





# Contents

## 10 Mineral Solutions

### Smooth and White

Ultima+  
Ultima+ OP  
Ultima+ dB  
Perla  
Perla OP 0.95  
Perla OP 1.00  
Perla dB  
Perla OP dB  
Dune eVo  
Dune eVo Max  
Dune eVo dB  
Sierra OP  
Optima  
Neeva  
Plain

### Classic

Fine Fissured

### Decorative

Colortone Range

## 48 Specific Solutions

Bioguard Plain (ISO 5)  
Bioguard Acoustic (ISO 5)  
Hygiene (ISO4)  
Clean Room FL (ISO 5)  
Hydroboard ( $\leq 100\%$  RH)  
Ceramaguard (100% RH)  
Aquabloc

## 64 Metal Ceilings

DecoMesh

## 67 Floating Ceiling Solutions

Axiom Canopies  
Axiom C Canopy  
Axiom C Canopy SL2 Planks  
Axiom KE Canopy  
Axiom Circle & Curved Canopy  
Axiom L Canopy  
Baffles  
Canopy

## 83 Suspension System Solutions

### General Applications

Prelude 15 TL & XL<sup>2</sup>  
Prelude 24 TLS  
Prelude 24 XL<sup>2</sup>  
Prelude 24 Sixty<sup>2</sup>  
System Z Prelude 24 / Corridor

### Design Options

Silhouette XL<sup>2</sup>  
Interlude HRC XL<sup>2</sup>

### Specific Applications

Prelude 24 Corrosive Resistant  
Clean Room 24 XL<sup>2</sup>  
Seismic RX<sup>®</sup>  
Prelude 35 XL<sup>2</sup>

### Perimeter Detailing

Perimeter Trims  
Accessories

### Axiom Solutions

Axiom Profiles  
Axiom Transitions  
Axiom Blind Boxes  
Axiom Perimeter Angles / Channels

## 111 Technical Information

Manufacturer's Recommendations  
Reaction to Fire  
Cleaning Matrix  
Acoustical Technical Glossary

# About Zentia

At Zentia we pride ourselves on being true pioneers in the design and manufacture of world-class mineral ceiling and suspension systems.



With our innovative solutions and a rich heritage which spans over 150 years, we are proud to be one of the greatest successes in the building materials industry.

From our deep rooted manufacturing origins and our solid Zentia brand foundation, we have evolved into Europe's leading manufacture of mineral fibre ceiling systems; with our products being specified in every environment from schools and workplaces to hotels and hospitals.

What's more our environmental commitment ensures we are striving for a sustainable future. From energy-saving performance features to responsible raw material selection our ceilings for sustainable building design are engineered to reduce environmental impact throughout their life cycle.

In fact, we are the first European mineral ceiling tile manufacturer to achieve Cradle to Cradle® certification. And, did you know, that every year in the UK and Ireland we continue to divert increasingly large amounts of waste from landfill through our ceiling recycling initiatives?

To this day our HQ and manufacturing facilities are based in Team Valley, Gateshead. We also operate in a further 7 countries across Europe.

Ongoing investment in our manufacturing plants and processes will support our continued growth and mission to offer our customers the very best products, value and service possible.

# Discover our new website

- // Zentia's website makes inspiration, specification and installation resources faster and easier to find than ever before
- // The intuitive website seamlessly adapts to mobile phones and tablets while maintaining a user-friendly experience
- // Browse products by range, category or application type, and scan product performance features at a glance
- // Related case studies, project photos, videos and installation details are easily accessible throughout the site

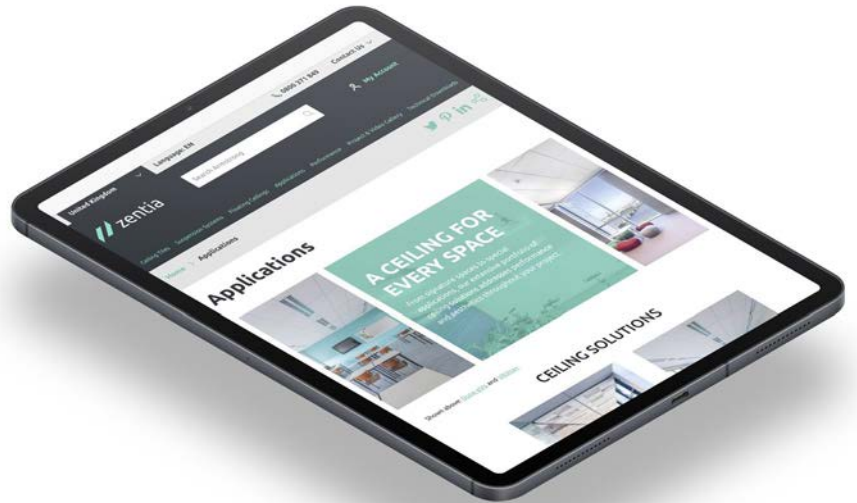

[zentia.com](http://zentia.com)

## Connect with us

Zentia is an avid user of social media platforms sharing design advice, technical expertise and the latest case studies, as well as new product developments and keeping you up to date with current industry news and views.

You can follow us on our social platforms, ask any questions you have and share your projects and achievements. Check out the options below.

### Get social with @zentia

Be inspired on **@Instagram**

Dig deeper with **@Pinterest**

Get a new perspective with **@YouTube**

Talk to us on **@Twitter**

Check out our people on **@LinkedIn**

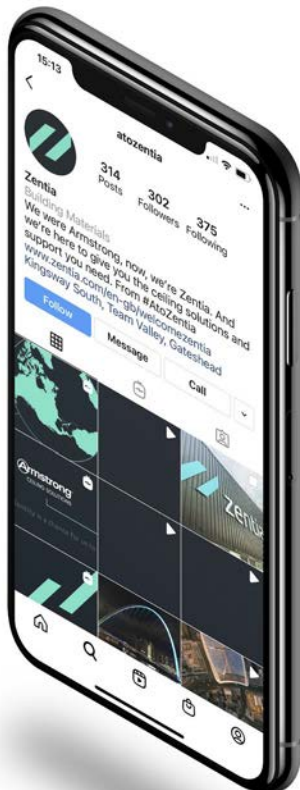

# Product selector by performance



Recycled Content (%)	Light Reflectance (%)	$\alpha_w$	Class	$D_{ncw} / D_{nfw}$ (dB)	Fire Reaction	% RH	Air Quality
----------------------	-----------------------	------------	-------	--------------------------	---------------	------	-------------

## Mineral Solutions

Ultima+	33 - 53	87	0.65(H) - 0.75(H)	C	33 - 40	A2-s1, d0	95	ISO 5 / A+
Ultima+ OP	23	87	1.00	A	25	A2-s1, d0	95	ISO 5 / A+
Ultima+ dB	64	87	0.60(H)	C	41 - 43	A2-s1, d0	95	ISO 5 / A+
Perla	52	86	0.65(H)	C	35	A2-s1, d0	95	ISO 5 / A+
Perla OP 0.95	22 - 51	85	0.95	A	25 - 27	A2-s1, d0	95	ISO 5 / A+
Perla 1.00	23	85	1.00	A	25	A2-s1, d0	95	ISO 5 / A+
Perla dB	64	86	0.50(H) - 0.60(H)	C	41 - 43	A2-s1, d0	95	ISO 5 / A+
Perla OP dB	21	85	0.90	A	40	A2-s1, d0	95	ISO 5 / A+
Dune eVo	44	85	0.60	C	34	A2-s1, d0	99	ISO 5 / A+
Dune eVo Max	46	85	0.65	C	35	A2-s1, d0	99	ISO 5 / A+
Dune eVo dB	37	85	0.60	C	39	A2-s1, d0	95	ISO 5 / A+
Sierra OP	15 - 50	84	0.90)	A	25 - 29	A2-s1, d0	95	ISO 5 / A+
Optima	77	87	0.90 - 1.00	A	24 (25mm)	A2-s1, d0	95	-
Neeva	20	82	0.90 - 1.00	A	24 - 27	A1	95	-
Plain	39	87	0.20(L)	E	35	A2-s1, d0	95	-
Fine Fissured	39 - 51	85	0.60(H)	C	34	A2-s1, d0	95	-
Colortone Dune eVo	44	-	0.55	D	35	A2-s1, d0	95	-
Colortone Neeva	20	-	1.00	A	24 (18mm)	d0 / A2-s2, d0	95	-
Colortone Fine Fissured	51	-	0.60(H)	C	36	A2-s1, d0	95	-

## Specific Solutions

Bioguard Plain	38 - 39	87	0.20(L)	E	35	A2-s1, d0	95	ISO 5
Bioguard Acoustic	41	85	0.60(H)	C	36	A2-s1, d0	95	ISO 5
Hygiene	20	82	0.95	A	-	A2-s1, d0	95	ISO 4
Clean Room FL	39	78	0.15	E	36	A2-s1, d0	95	ISO 5
Hydroboard	20	82	0.95	A	22	A1	100	-
Ceramaguard	37	79	0.55(MH)	D	39	A1	100	-
Aquabloc	30	84	0.10(L)	-	37	A1	100	-

## Metal Ceilings

DecoMesh	48	-	-	-	-	A2-s1, d0	95	-
----------	----	---	---	---	---	-----------	----	---

## Floating Ceilings

Axiom Canopy C, L, KE, Circle & Curved	25	=<90	Dependant on size and panel infill		N/A	A2-s1, d0	N/A	-
Baffles	85	87	0.60(MH)	C	N/A	A2-s2, d0	90	-
Canopy	85	87	Dependant on size		N/A	A2-s2, d0	90	-

# Suspension Systems

## General Applications:

- // Prelude 15 TL & XL<sup>2</sup>
- // Prelude 24 TLS & XL<sup>2</sup>
- // Prelude 24 Sixty<sup>2</sup>
- // Prelude 35 XL<sup>2</sup>
- // System Z (Prelude 24 / Corridor)

## Design Options:

- // Silhouette XL<sup>2</sup>, Interlude HRC XL<sup>2</sup>

## Sustainable Performance:

- // Prelude 15 TL & XL<sup>2</sup>
- // Prelude 24 TLS & XL<sup>2</sup>
- // Prelude 24 Sixty<sup>2</sup>
- // Prelude 35 XL<sup>2</sup>
- // System Z (Prelude 24 / Corridor)

## High Load Performance:

- // Prelude 24 Sixty<sup>2</sup>

## Plasterboard & Perimeter Solutions:

- // Axiom Transitions
- // Axiom Profiles
- // Axiom Blind Boxes
- // Axiom Perimeter Trims

## Seismic Performance:

- // Seismic Rx

## Clean Room Performance:

- // Clean Room 24

## High Humidity Performance:

- // Prelude 24 Corrosive Resistant

## Long Span Solutions:

- // Prelude 24 Sixty<sup>2</sup>



# Definition of Technical Performance Icons



## 30 Year System Guarantee

Products which, when installed with the compatible Zentia tile/grid/accessories, have the Zentia 30 Year System Guarantee.



## Sound Absorption

A single-number rating for random incidence sound absorption coefficients as calculated by reference to EN ISO 11654 ( $\alpha_w$ ) or, as calculated by reference to ASTM C423 (NRC).



## Sound Absorption Class

A classification for sound absorption (A – E) based upon the sound absorption  $\alpha_w$  value.



## Sound Reduction

A single-number rating for airborne sound transmission (single pass) as calculated by reference to EN ISO 717-1.



## Sound Attenuation

A single-number rating for flanking sound transmission between adjacent rooms, as calculated by reference to EN ISO 717-1.



## Fire Reaction

Reaction to fire classification in accordance with EN 13501-1 expressed as Euroclass (A1 – F).



## Humidity Resistance

Maximum relative humidity conditions for installation and lifetime of ceiling.



## Light Reflectance

Light reflection is the proportion of incident light that is reflected back off the product, when tested in accordance with EN ISO 7724-2 and 3.



## Light Diffusion

The percentage of reflected light which is diffused.



## Air Quality

Zentia solutions designed to limit the number of airborne particles in a clean room environment are tested against ISO 14644-1 and classified with an ISO class.



## Thermal Conductivity

Tested in accordance with EN 12667, the thermal conductivity rating measures the rate of heat flow through a material.



## Scratch Resistance

Products with this icon offer a superior level of surface scratch resistance, evaluated with the Hess Rake test.



## Product Handling & Durability

Solutions with enhanced durability for improved handling and resistance to damage.



## Weight

Weight per unit area of the product (kg/m<sup>2</sup>).



## Colours

Custom colours available for products with this icon.



## Dimensions

Custom sizes available for products with this icon.



## Grid Systems

Additional compatible grid systems available upon request.



## Shapes

Custom shapes available for products with this icon.



## Bioguard / Antimicrobial

Bioguard antimicrobial finish as standard on Bioguard Plain and Bioguard Acoustic mineral tiles with this icon.



## Seismic

Seismic resistance using specifically designed components and assemblies available for systems with this icon.



## Service Integration

Custom factory cut-outs for service integration available for products with this icon.



# Cleaning and Disinfection

The frequency and cleaning method of a ceiling varies from one application to another. All products can at least be cleaned with a dry cloth or vacuum cleaner.



## Wipeable

With a dry cloth / soft brush.



## Wipeable

With a moist cloth.



## Washable

With a sponge dampened in water containing mild soap or diluted detergent.



## Scrubable

With water containing mild soap or diluted detergent.



## Water Spray

Can be cleaned using a high pressure water spray.



## Disinfectant

Can be cleaned with disinfectants commonly used in healthcare premises.

# Sustainability

Products with this icon are C2C certified, providing a transparent mechanism to compare the sustainability performance of products, showing that they are designed for recycling and can help protect and sustain our environment for future generations by keeping resources in the economy for longer.



## Recycled Content

The recycled content of the product, as calculated in accordance with ISO 14021.



## Recycling Programme

Products with this icon can be recycled through the Zentia Ceiling Recycling Programme. UK / Ireland only.



## VOC

The VOC emission performance in accordance with the French labelling requirements.



## Formaldehyde (E1)

Formaldehyde emission level (E1 = Best test result possible).



## BIM

BIM objects available for products with this icon.

# CE Marking



In Europe, the Construction Products Regulations (305/2011/ EU) defines essential requirements for products (and projects) such that they are safe and fit for their intended use. Harmonized Product Standards respond to these essential requirements and set out what tests must be conducted and how the performance must be communicated. For suspended ceilings the applicable product standard is EN 13964 Suspended Ceilings – Requirements & Test Methods.

The essential requirements identified for suspended ceiling Membranes (tiles) include:

- // Reaction to Fire (mandatory)
- // Formaldehyde Emissions (mandatory)
- // Sound Absorption
- // Flexural Tensile Strength / Durability
- // Thermal Conductivity

It is mandatory to CE Mark products within the scope of EN 13964 and provide a Declaration of Performance in order to place the product on the market.

All Zentia Declarations of Performance can be found on Zentia's website.



## Mineral solutions

The broadest range of textures, sizes and shapes with key performance features to enhance the design of any space. Our mineral ceilings provide solutions for every acoustical need from high sound absorption to high sound attenuation or a balance of both. For each segment and area, we offer a specific solution.

- // Smooth and white
- // Decorative
- // Classic
- // Monolithic

# Focus on Dune eVo, Perla & Ultima+ ranges

## Dune eVo

The tile and grid system with Cradle to Cradle® Certified accreditation. Helping to meet zero landfill targets, DUNE eVo is 100% recyclable, ensuring countless new beginnings on projects across all industry sectors.

### Reinforced edges

- // Less damage in storage and installation

### Range of sizes

- // More 'mix and match'

### Acoustical absorption

- // Less noise, more comfort

### Aesthetics

- // Whiter and brighter

### Texture and properties

- // Easy to handle

### Packaging

- // Stronger and clearer with more impact

## Colourtone Dune eVo

For decorative solutions, the Colortone range offers modern designs, textures and darker colours, adding interest and depth to your interiors.

The new Colortone Dune eVo has:

- // New finer surface
- // Discreet perforation
- // Improved sound absorption
- // MicroLook 90 edge detail

## Perla

A single visual for your different acoustical requirements:

- // Standard solution provides a balanced acoustic between absorption and attenuation
- // OP solution is designed for high absorption and improved concentration, ideal for open plan spaces
- // 3 levels of acoustics: Standard, OP, dB
- // Best in class fully painted edges: less damage in storage and installation

- // Easy to handle: re-engineered for a better, easier fit
- // Non-directional surface making it faster to install
- // ISO 5 particle cleanliness creates better surroundings, increasing comfort and well-being to tackle even the most demanding environments

## Ultima+

Same advantages as Perla, plus...

- // Widest range of edges, modules and acoustic options giving you complete noise control and design flexibility for every space
- // Most uniform installed appearance and more even light distribution due to low gloss levels (0.2%)
- // More robust, retaining its aesthetics for longer
- // Whitest, brightest, longest lasting durable finish and visual due to its unique lightly textured surface

## Ultima+ Finesse

Available with Ultima+, the new Finesse edge detail provides a sleek monolithic solution with no visible grid.

- // A unique uniform visual with simple access to the void
- // Flexible service integration allowing to pre-define the points of accessibility before installation
- // An optimised suspension system balancing ease and speed of installation with system stability





## Ultima<sup>+</sup>

Ultima<sup>+</sup> not only offers a finely textured and durable surface with a brighter 'blue-white' colour and high light reflectance, it also offers a balance of both sound absorption and sound attenuation.

## Key Features

- /// Good sound absorption: up to 0.75  $\alpha_w$
- /// Very high light reflectance: 87%
- /// Reinforced scratch resistant face
- /// Better finish and more durable edges
- /// ISO 5 / A+
- /// 30 year system guarantee
- /// Available with SL2 MicroLook 90 edge detail
- /// Ideal for meeting rooms or waiting areas
- /// Ultima+ Planks: Ideal for both open areas and corridors

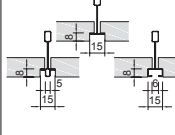
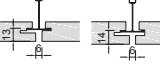
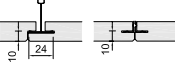
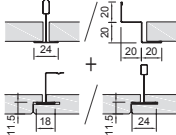
Edge Detail	Board	Tegular	MicroLook 90	Vector	Finesse	SL2
						
<b>Thickness (mm)</b>	19	19	19	19	19	19
<b>Modules (mm)</b>	600 x 600 ..7661M 1200 x 600 .7663M	600 x 600 ..7664M 1200 x 600 .7666M	600 x 600 ..7674M 1200 x 600 .7677M	600 x 600 ..7681M	600 x 600 ..7715M 1200 x 600 .7716M	1500 x 300 .7699M 1800 x 300 .7701M 2500 x 300 .7702M
<b>Suspension Systems</b>	Prelude 24 XL <sup>2</sup> /TLS Prelude 24 Sixty <sup>2</sup> XL <sup>2</sup> /TLS	Prelude 24 XL <sup>2</sup> /TLS Prelude 24 Sixty <sup>2</sup> XL <sup>2</sup> /TLS	Prelude TL/XL <sup>2</sup> Interlude HRC XL <sup>2</sup> Silhouette XL <sup>2</sup>	Prelude 24 XL <sup>2</sup> /TLS Prelude 24 Sixty <sup>2</sup> XL <sup>2</sup> /TLS	System Z – L-Bar	System Z - T-Bar System Z - Z-Bar

**Colour** Global White

## Sustainability



33-53<sup>1</sup>



A+<sup>2</sup>



EN 13964 / E1

<sup>1</sup>Depends on thickness, edge detail and size of tile

<sup>2</sup>Except Vector: A

## Acoustics



EN ISO 354  
& EN ISO 11654



EN ISO 10848-2  
& EN ISO 717-1



EN ISO 140-3  
& EN ISO 717-1

Hz  $\alpha_p$

	$\alpha_w$	D <sub>nfw</sub>	R <sub>w</sub>	Class	NRC	125	250	500	1000	2000	4000
Board, Tegular, MicroLook 90	0.70(H)	36 dB	18 dB	C	0.75	0.40	0.50	0.65	0.85	0.95	1.00
Vector	0.75(H)	33 dB	-	C	0.75	0.35	0.55	0.65	0.80	0.95	0.90
Finesse	0.70(H)	39 dB	-	C	0.75	0.40	0.50	0.65	0.85	0.95	1.00
SL2	0.65(H)	40 dB	-	C	0.65	0.35	0.45	0.55	0.75	0.90	1.00

## Fire Reaction



EEA Euroclass A2-s1, d0  
EN 13501-1

## Performances & Features



87%



95% RH



ISO 5



ISO 14644-1



30 Year  
System  
Guarantee



$\lambda=0.052$   
W/m K  
EN 12667  
& ISO 8301



5.0 Kg/m<sup>2</sup>  
Board, Tegular,  
MicroLook 90  
5.6 Kg/m<sup>2</sup> SL2  
5.8 Kg/m<sup>2</sup> Vector



BIM  
READY

## Custom Options



Dimensions





## Ultima+ OP

Ultima+ OP not only offers a finely textured and durable surface with a brighter 'blue-white' colour and high light reflectance, provides Class A sound absorption, making it ideal for open plan areas.

## Key Features

- Excellent sound absorption:  $1.00 \alpha_w$
- Very high light reflectance: 87%
- Better finish and more durable edges
- 30 year system guarantee
- Ideal for open spaces, vibrant open plan offices and cafeterias

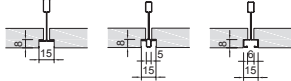
Edge Detail	Board	Tegular	MicroLook 90
			
<b>Thickness (mm)</b>	20	20	20
<b>Modules (mm)</b>	600 x 600 ..... 7682M 1200 x 600 ..... 7684M	600 x 600 ..... 7678M 600 x 600 ..... 7680M	600 x 600 ..... 7685M 600 x 600 ..... 7687M 1500 x 600 ..... 7708M
<b>Suspension Systems</b>	Prelude 24 XL <sup>2</sup> / TLS Prelude 24 Sixty <sup>2</sup> XL <sup>2</sup> / TLS	Prelude 24 XL <sup>2</sup> / TLS Prelude 24 Sixty <sup>2</sup> XL <sup>2</sup> / TLS	Prelude 15 TL / XL <sup>2</sup> Interlude HRC XL <sup>2</sup> Silhouette XL <sup>2</sup>

**Colour** Global White

## Sustainability



23



A+



EN 13964 / E1

## Acoustics



EN ISO 354  
& EN ISO 11654



EN ISO 10848-2  
& EN ISO 717-1



EN ISO 140-3  
& EN ISO 717-1

	Hz $\alpha_p$										
	$\alpha_w$	D <sub>nfw</sub>	R <sub>w</sub>	Class	NRC	125	250	500	1000	2000	4000
Board, Tegular, MicroLook 90	1.00	25 dB	10 dB	A	0.95	0.40	0.80	1.00	0.95	1.00	1.00

## Fire Reaction



EEA Euroclass A2-s1, d0  
EN 13501-1

## Performances & Features



87%



95% RH



ISO 5



ISO 14644-1



30 Year System Guarantee



$\lambda=0.037$   
W/m K  
EN 12667  
& ISO 8301



3.2 Kg/m<sup>2</sup>



BIM READY

## Custom Options



Dimensions



## Ultima+ dB

Ultima+ dB not only offers a finely textured and durable surface with a brighter 'blue-white' colour for high light reflectance, providing higher levels of sound attenuation performance for improving the privacy between adjacent spaces.



## Key Features

- ✓ Eliminates the need for sound barriers in closed offices
- ✓ Very high light reflectance: 87%
- ✓ Better finish and more durable edges
- ✓ 30 year system guarantee
- ✓ Ideal for individual / private offices and boardrooms

Edge Detail	Board	Tegular	MicroLook 90
<b>Thickness (mm)</b>	19	19	19
<b>Modules (mm)</b>	600 x 600 ..... 7688M 1200 x 600 ..... 7690M	600 x 600 ..... 7695M	600 x 600 ..... 7697M
<b>Suspension Systems</b>	Prelude 24 XL <sup>2</sup> / TLS Prelude 24 Sixty <sup>2</sup> XL <sup>2</sup> / TLS	Prelude 24 XL <sup>2</sup> / TLS Prelude 24 Sixty <sup>2</sup> XL <sup>2</sup> / TLS	Prelude 15 TL / XL <sup>2</sup> Interlude HRC XL <sup>2</sup> Silhouette XL <sup>2</sup>

**Colour** Global White

## Sustainability



64



A+



EN 13964 / E1

## Acoustics



EN ISO 140-3  
& EN ISO 717-1



EN ISO 354  
& EN ISO 11654



EN ISO 10848-2  
& EN ISO 717-1

	$\alpha_w$	D <sub>nfw</sub>	R <sub>w</sub>	Class	NRC	Hz $\alpha_p$						
						125	250	500	1000	2000	4000	
Board, Tegular, MicroLook 90	0.60(H)	41 dB	21 dB	C	0.65	0.25	0.35	0.55	0.80	0.90	0.95	

## Fire Reaction



EEA Euroclass A2-s1, d0  
EN 13501-1

## Performances & Features



87%



95% RH



ISO 5



ISO 14644-1



30 Year  
System  
Guarantee



$\lambda=0.067\text{W/mK}$   
EN 12667  
& ISO 8301



7.6 Kg/m<sup>2</sup>



BIM  
READY

## Custom Options



Dimensions



## Perla

Perla is a smooth laminated finish providing balanced acoustic performance combining both sound absorption and sound attenuation.

## Key Features

- ✓ Winning balance of sound attenuation and absorption
- ✓ Enhanced product durability
- ✓ High light reflectance: 86%
- ✓ ISO 5 / A+
- ✓ Ideal for open plan offices, board rooms, SEN schools and libraries

Edge Detail	Board	Tegular	MicroLook 90
<b>Thickness (mm)</b>	17	17	17
<b>Modules (mm)</b>	600 x 600 ..... 2801M 1200 x 600 ..... 2802M	600 x 600 ..... 2803M	600 x 600 ..... 2805M 1500 x 600 ..... 5181M
<b>Suspension Systems</b>	Prelude 24 XL <sup>2</sup> / TLS Prelude 24 Sixty <sup>2</sup> XL <sup>2</sup> / TLS	Prelude 24 XL <sup>2</sup> / TLS Prelude 24 Sixty <sup>2</sup> XL <sup>2</sup> / TLS	Prelude 15 TL / XL <sup>2</sup> Interlude HRC XL <sup>2</sup> Silhouette XL <sup>2</sup>

**Colour** Global White

## Sustainability



52



A+



EN 13964 / E1

## Acoustics



EN ISO 354  
& EN ISO 11654



EN ISO 10848-2  
& EN ISO 717-1



EN ISO 140-3  
& EN ISO 717-1

	$\alpha_w$	$D_{nfw}$	$R_w$	Class	NRC	Hz $\alpha_p$					
						125	250	500	1000	2000	4000
Board, Tegular, MicroLook 90	0.65(H)	35 dB	18 dB	C	0.70	0.35	0.40	0.60	0.85	0.95	1.00

## Fire Reaction



EEA Euroclass A2-s1, d0  
EN 13501-1

## Performances & Features



86%



95% RH



30 Year  
System  
Guarantee



$\lambda=0.052$   
W/m K  
EN 12667  
& ISO 8301



4.6 Kg/m<sup>2</sup>



ISO 5

ISO 14644-1



BIM  
READY

## Custom Options



Dimensions





## Perla OP 0.95

Perla OP 0.95 is a smooth laminated finish and Class A sound absorption, making it ideal for open plan areas.

## Key Features

- Excellent sound absorption: up to  $0.95 \alpha_w$
- Better finish and more durable edges
- Available with SL2 edge detail
- Ideal for open spaces, call centres, libraries and schools

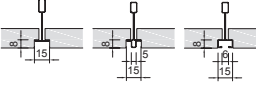
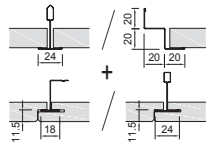
Edge Detail	Board	Tegular	MicroLook 90	SL2
				
<b>Thickness (mm)</b>	15 / 18	15	15 / 18	18
<b>Modules (mm)</b>	600 x 600 x 15...3819M 1200 x 600 x 15...3821M 150 x 600 x 18...3092M	600 x 600 x 15...5173M 600 x 600 x 20...5177M	600 x 600 x 15...5174M 600 x 600 x 15...5178M 600 x 600 x 18...5188M	1500 x 300...3094M 1800 x 300...3096M
<b>Suspension Systems</b>	Prelude 24 XL <sup>2</sup> /TLS Prelude 24 Sixty <sup>2</sup> XL <sup>2</sup> /TLS	Prelude 24 XL <sup>2</sup> /TLS Prelude 24 Sixty <sup>2</sup> XL <sup>2</sup> /TLS	Prelude 15 15 TL/XL <sup>2</sup> Interlude HRC XL <sup>2</sup> Silhouette XL <sup>2</sup>	System Z – T-Bar System Z – Z-Bar

**Colour** Global White

## Sustainability



20-51<sup>1</sup>



A+



EN 13964 / E1

<sup>1</sup>Depends on thickness, edge detail and size of tile

## Acoustics



EN ISO 354  
& EN ISO 11654



EN ISO 10848-2  
& EN ISO 717-1



EN ISO 140-3  
& EN ISO 717-1

Hz  $\alpha_p$

	$\alpha_w$	$D_{nfw}$	$R_w$	Class	NRC	125	250	500	1000	2000	4000
Board, Tegular, MicroLook 90 (15mm)	0.95	25 dB	12 dB	A	0.90	0.45	0.80	0.95	0.90	1.00	1.00
Board, MicroLook 90 (18mm)	0.95	25 dB	10 dB	A	0.90	0.50	0.85	0.95	0.90	1.00	1.00
SL2	0.95	27 dB	-	A	0.90	0.45	0.85	0.95	0.90	0.95	1.00

## Fire Reaction



EEA Euroclass A2-s1, d0  
EN 13501-1

## Performances & Features



85%



95% RH<sup>2</sup>



ISO 5



ISO 14644-1



<sup>2</sup>Except 5177M & 5178M (70% RH)



$\lambda = 0.037$   
W/m K  
EN 12667  
& ISO 8301



2.4 Kg/m<sup>2</sup> (15mm)  
2.9 Kg/m<sup>2</sup> (18mm)  
3.3 Kg/m<sup>2</sup> (Planks)



## Custom Options



Dimensions



## Perla OP 1.00

Perla OP 1.00 is a smooth laminated finish and offers the highest level of sound absorption ( $1.00 \alpha_w$ ), making it ideal for open plan spaces.

## Key Features

- Excellent sound absorption:  $1.00 \alpha_w$
- High light reflectance: 85%
- Better finish and more durable edges
- Ideal for open spaces, call centres, open plan offices and SEN schools

Edge Detail	Board	Tegular	MicroLook 90
<b>Thickness (mm)</b>	20	20	20
<b>Modules (mm)</b>	600 x 600 ..... 3861M 1200 x 600 ..... 3863M	600 x 600 ..... 3866M 1200 x 600 ..... 3855M	600 x 600 ..... 2097M
<b>Suspension Systems</b>	Prelude 24 XL <sup>2</sup> / TLS Prelude 24 Sixty <sup>2</sup> XL <sup>2</sup> / TLS	Prelude 24 XL <sup>2</sup> / TLS Prelude 24 Sixty <sup>2</sup> XL <sup>2</sup> / TLS	Prelude 15 TL / XL <sup>2</sup> Interlude HRC XL <sup>2</sup> Silhouette XL <sup>2</sup>

**Colour** Global White

## Sustainability



23



A+



EN 13964 / E1

## Acoustics



EN ISO 354  
& EN ISO 11654



EN ISO 10848-2  
& EN ISO 717-1



EN ISO 140-3  
& EN ISO 717-1

	$\alpha_w$	$D_{nfw}$	$R_w$	Class	NRC	Hz $\alpha_p$					
						125	250	500	1000	2000	4000
Board, Tegular, MicroLook 90	1.00	25 dB	12 dB	A	0.95	0.50	0.85	0.95	0.95	1.00	1.00

## Fire Reaction



EEA Euroclass A2-s1, d0  
EN 13501-1

## Performances & Features



85%



95% RH



30 Year  
System  
Guarantee



$\lambda=0.037$   
W/m K  
EN 12667  
& ISO 8301



3.1 Kg/m<sup>2</sup>



ISO 5



ISO 14644-1



BIM  
READY

## Custom Options



Dimensions



## Perla dB

Perla dB is a smooth laminated finish providing enhanced sound attenuation performance for improving the privacy between adjacent spaces.



## Key Features

- Excellent level of sound attenuation: up to 41 dB
- High recycled content: 64%
- High light reflectance: 86%
- Better finish and more durable edges
- ISO 5 / A+
- Ideal for individual offices

Edge Detail	Board	Tegular	MicroLook 90
<b>Thickness (mm)</b>	19	19	19
<b>Modules (mm)</b>	600 x 600 ..... 3191M	600 x 600 ..... 3192M	600 x 600 ..... 2095M
<b>Suspension Systems</b>	Prelude 24 XL <sup>2</sup> / TLS Prelude 24 Sixty <sup>2</sup> XL <sup>2</sup> / TLS	Prelude 24 XL <sup>2</sup> / TLS Prelude 24 Sixty <sup>2</sup> XL <sup>2</sup> / TLS	Prelude 15 TL/ XL <sup>2</sup> Interlude HRC XL <sup>2</sup> Silhouette XL <sup>2</sup>
<b>Colour</b>	Global White		

## Sustainability



64



A+



EN 13964 / E1

## Acoustics



EN ISO 354  
& EN ISO 11654



EN ISO 10848-2  
& EN ISO 717-1



EN ISO 140-3  
& EN ISO 717-1

	Hz $\alpha_p$										
	$\alpha_w$	D <sub>nfw</sub>	R <sub>w</sub>	Class	NRC	125	250	500	1000	2000	4000
Board, Tegular, MicroLook 90	0.60(H)	41 dB	21 dB	C	0.65	0.30	0.40	0.55	0.70	0.85	0.95

## Fire Reaction



EEA Euroclass A2-s1, d0  
EN 13501-1

## Performances & Features



86%



95% RH



30 Year  
System  
Guarantee



$\lambda=0.067$   
W/m K  
EN 12667  
& ISO 8301



7.6 Kg/m<sup>2</sup>



ISO 5



ISO 14644-1

BIM  
READY

## Custom Options



Dimensions



## Perla OP dB

Perla OP dB combines the smooth Perla laminated appearance with the highest levels of sound absorption and sound attenuation in one tile, providing a solution for flexible working spaces.

## Key Features

- Perla OP dB includes a large selection of sizes and quality edge details enhancing durability
- The best acoustical combination of high sound absorption and high sound attenuation properties
- Ideal for open plan offices, board rooms, SEN schools and libraries

Edge Detail	Board	Tegular	MicroLook 90
<b>Thickness (mm)</b>	40	40	40
<b>Modules (mm)</b>	600 x 600 ..... 5044M 1200 x 600 ..... 5045M	600 x 600 ..... 5104M	600 x 600 ..... 5114M
<b>Suspension Systems</b>	Prelude 24 XL <sup>2</sup> / TLS Prelude 24 Sixty <sup>2</sup> XL <sup>2</sup> / TLS	Prelude 24 XL <sup>2</sup> / TLS Prelude 24 Sixty <sup>2</sup> XL <sup>2</sup> / TLS	Prelude 15 TL / XL <sup>2</sup> Interlude HRC XL <sup>2</sup> Silhouette XL <sup>2</sup>

**Colour** Global White

## Sustainability



21



A+



EN 13964 / E1

## Acoustics



EN ISO 354  
& EN ISO 11654



EN ISO 10848-2  
& EN ISO 717-1



EN ISO 140-3  
& EN ISO 717-1

	Hz $\alpha_p$										
	$\alpha_w$	$D_{nfw}$	$R_w$	Class	NRC	125	250	500	1000	2000	4000
Board, Tegular, MicroLook 90	0.90	40 dB	20 dB	A	0.85	0.35	0.60	0.90	1.00	1.00	1.00

## Fire Reaction



EEA Euroclass A2-s1, d0  
EN 13501-1

## Performances & Features



85%



95% RH



30 Year  
System  
Guarantee



$\lambda=0.037$   
W/m K  
EN 12667  
& ISO 8301



6.2 Kg/m<sup>2</sup>



ISO 5



ISO 14644-1

BIM  
READY



## Dune eVo

In every sector from transport to retail, and in every environment from hotels and hospitals to schools and workplaces, Dune eVo is designed to meet all your project needs. Dune eVo is 100% recyclable to meet your sustainability targets.

## Key Features

- // Improved aesthetics with discreet perforations, a smoother finish and a class-leading, fully painted whiteness
- // Enhanced acoustical absorption performance of 0.60  $\alpha_w$  for better acoustic comfort
- // Fully painted, reinforced edges for a more robust tile and greater durability
- // Mix and match modules for increased flexibility and a more complete project solution
- // Easy to handle and re-engineered for a better, easier fit
- // Ideal for every space

Edge Detail	Board	Tegular	MicroLook 90
<b>Thickness (mm)</b>	15	15	15
<b>Modules (mm)</b>	600 x 600 ..... 5460M 1200 x 600 ..... 5461M	600 x 600 ..... 5462M 1200 x 600 ..... 5463M	600 x 600 ..... 5464M 1200 x 600 ..... 5465M
<b>Suspension Systems</b>	Prelude 24 XL <sup>2</sup> / TLS Prelude 24 Sixty <sup>2</sup> XL <sup>2</sup> / TLS	Prelude 24 XL <sup>2</sup> / TLS Prelude 24 Sixty <sup>2</sup> XL <sup>2</sup> / TLS	Prelude 15 TL / XL <sup>2</sup> Interlude HRC XL <sup>2</sup> Silhouette XL <sup>2</sup>

**Colour** Global White

## Sustainability



44



A+



EN 13964 / E1

## Acoustics



EN ISO 354  
& EN ISO 11654



EN ISO 10848-2  
& EN ISO 717-1

	$\alpha_w$	D <sub>nfw</sub>	Class	NRC	125	250	500	1000	2000	4000
Board, Tegular, MicroLook 90	0.60	34 dB	C	0.50	0.40	0.40	0.60	0.55	0.55	0.50

## Fire Reaction



EEA Euroclass A2-s1, d0  
EN 13501-1

## Performances & Features



85%



99% RH



Lifetime  
Guarantee

30 Year  
System  
Guarantee



$\lambda=0.060$   
W/m K  
EN 12667  
& ISO 8301



3.6 Kg/m<sup>2</sup>



BIM  
READY

## Custom Options



Dimensions



## Dune eVo Max

Dune eVo Max with its microperforated, finely sanded surface, offers improved levels of sound absorption and sound attenuation, making it a great choice for classrooms and other areas requiring Class C sound absorption.

## Key Features

- // Improved aesthetics with discreet perforations, a smoother finish and a class-leading, fully painted whiteness
- // Balanced acoustical absorption performance of  $0.65 \alpha_w$  and sound attenuation of 35dB
- // Fully painted, reinforced edges for a more robust tile and greater durability
- // Easy to handle and re-engineered for a better, easier fit
- // Ideal for classroom and general teaching conditions

Edge Detail	Board	Tegular	MicroLook 90
<b>Thickness (mm)</b>	18	18	18
<b>Modules (mm)</b>	600 x 600 ..... 5471M 1200 x 600 ..... 5472M	600 x 600 ..... 5473M	600 x 600 ..... 5475M
<b>Suspension Systems</b>	Prelude 24 XL <sup>2</sup> / TLS Prelude 24 Sixty <sup>2</sup> XL <sup>2</sup> / TLS	Prelude 24 XL <sup>2</sup> / TLS Prelude 24 Sixty <sup>2</sup> XL <sup>2</sup> / TLS	Prelude 15 TL / XL <sup>2</sup> Interlude HRC XL <sup>2</sup> Silhouette XL <sup>2</sup>

**Colour** Global White

## Sustainability



46



A



EN 13964 / E1

## Acoustics



EN ISO 354  
& EN ISO 11654



EN ISO 10848-2  
& EN ISO 717-1



EN ISO 140-3  
& EN ISO 717-1

	$\alpha_w$	D <sub>nfw</sub>	R <sub>w</sub>	Class	NRC	Hz $\alpha_p$						
						125	250	500	1000	2000	4000	
Board, Tegular, MicroLook 90	0.65	35 dB	17 dB	C	0.60	0.35	0.45	0.60	0.65	0.70	0.65	

## Fire Reaction



EEA Euroclass A2-s1, d0  
EN 13501-1

## Performances & Features



85%



99% RH



Lifetime  
Guarantee

30 Year  
System  
Guarantee



$\lambda=0.060$   
W/m K  
EN 12667  
& ISO 8301



4.3 Kg/m<sup>2</sup>



BIM  
READY

## Custom Options



Dimensions



## Dune eVo dB

The higher attenuation performance of Dune eVo dB offers a perfect solution for improving the privacy between adjacent spaces. Whilst the class-leading whiteness helps to create spaces that are brighter and better, and which offer a greater sense of well-being for your customers.



## Key Features

- ✔ Excellent sound attenuation (39 dB sound reduction) to eliminate the need for sound barriers in close office applications
- ✔ Enhanced acoustical absorption performance of 0.60  $\alpha_w$  for better acoustic comfort
- ✔ Fully painted, reinforced edges for a more robust tile and greater durability
- ✔ Improved aesthetics with discreet perforations, a smoother finish and a class-leading, fully painted whiteness
- ✔ Easy to handle and re-engineered for a better, easier fit
- ✔ Ideal for individual offices and board rooms

Edge Detail	Board	Tegular	Microlook 90
<b>Thickness (mm)</b>	19	19	19
<b>Modules (mm)</b>	600 x 600 ..... 5477M	600 x 600 ..... 5479M	600 x 600 ..... 5481M
<b>Suspension Systems</b>	Prelude 24 XL <sup>2</sup> / TLS Prelude 24 Sixty <sup>2</sup> XL <sup>2</sup> / TLS	Prelude 24 XL <sup>2</sup> / TLS Prelude 24 Sixty <sup>2</sup> XL <sup>2</sup> / TLS	Prelude 15 TL / TLS Interlude HRC XL <sup>2</sup> Silhouette XL <sup>2</sup>
<b>Colour</b>	Global White		

## Sustainability



37



A+



EN 13964 / E1

## Acoustics



EN ISO 354  
& EN ISO 11654



EN ISO 10848-2  
& EN ISO 717-1



EN ISO 140-3  
& EN ISO 717-1

	$\alpha_w$	D <sub>nfw</sub>	R <sub>w</sub>	Class	NRC	Hz $\alpha_p$						
						125	250	500	1000	2000	4000	
Board, Tegular, MicroLook 90	0.60	39 dB	20 dB	C	0.55	0.35	0.40	0.60	0.65	0.75	0.65	

## Fire Reaction



EEA Euroclass A2-s1, d0  
EN 13501-1

## Performances & Features



85%



95% RH



$\lambda=0.067$   
W/m K  
EN 12667  
& ISO 8301



7.9 Kg/m<sup>2</sup>



## Custom Options



Dimensions



## Sierra OP

Sierra OP is a laminated mineral tile offering a smooth white appearance combined with Class A acoustic performance.

## Key Features

- High level of sound absorption, up to  $0.90 \alpha_w$
- Long-lasting solution, easy to clean
- ISO 5
- Ideal for open spaces, call centres, libraries and cafeterias

Edge Detail	Board	Tegular	MicroLook 90
Thickness (mm)	15 / 17	15	15
Modules (mm)	600 x 600 x 15.....4115M 1200 x 600 x 15.....4117M 1500 x 600 x 17 .....3782M	600 x 600 x 15..... 4200M	600 x 600 x 15.....4202M
Suspension Systems	Prelude 24 XL <sup>2</sup> / TLS Prelude 24 Sixty <sup>2</sup> XL <sup>2</sup> / TLS	Prelude 24 XL <sup>2</sup> / TLS Prelude 24 Sixty <sup>2</sup> XL <sup>2</sup> / TLS	Prelude 15 TL / XL <sup>2</sup> Interlude HRC XL <sup>2</sup> Silhouette XL <sup>2</sup>

Colour Global White

## Sustainability



15 - 50<sup>1</sup>



A+



EN 13964 / E1

<sup>1</sup>Depends on thickness, edge detail and size of tile

## Acoustics



EN ISO 354  
& EN ISO 11654



EN ISO 10848-2  
& EN ISO 717-1



EN ISO 140-3  
& EN ISO 717-1

	Hz $\alpha_p$										
	$\alpha_w$	D <sub>nfw</sub>	R <sub>w</sub>	Class	NRC	125	250	500	1000	2000	4000
Board, Tegular, MicroLook 90 -15mm	0.90	25 dB	12 dB	A	0.85	0.45	0.75	0.85	0.85	1.00	1.00
Board – 17mm	0.90	27 dB	11 dB	A	0.85	0.50	0.75	0.85	0.85	1.00	1.00

## Fire Reaction



EEA Euroclass A2-s1, d0  
EN 13501-1

## Performances & Features



84%



≥95% RH<sup>2</sup>



30 Year  
System  
Guarantee



$\lambda=0.036$  W/m K (15mm)  
 $\lambda=0.037$  W/m K (17mm)

EN 12667  
& ISO 8301



2.4 Kg/m<sup>2</sup>  
(15mm)  
3.2 Kg/m<sup>2</sup>  
(17mm)



ISO 5

ISO 14644-1



BIM  
READY

## Custom Options



Dimensions

<sup>2</sup>Except 4204M & 4205M



# Optima

Optima has a fine textured surface and offers Class A sound absorption finish with fibre scrim.

## Key Features

- Excellent sound absorption: up to 1.00  $\alpha_w$
- High light reflectance: 87%
- Excellent mechanical strength (fibre glass fleece at the back)

Edge Detail	Board	Tegular	MicroLook 90	Vector
<b>Thickness (mm)</b>	15 / 20	15 / 20	15 / 20	22
<b>Modules (mm)</b>	600 x 600 x 15...2327M 1200 x 600 x 15...2328M 600 x 600 x 20...2335M	600 x 600 x 15...2329M 600 x 600 x 20...2349M	600 x 600 x 15...2331M 600 x 600 x 20...2363M	600 x 600...2387M 1200 x 600...3413M
<b>Suspension Systems</b>	Prelude 24 XL <sup>2</sup> /TLS Prelude 24 Sixty <sup>2</sup> XL <sup>2</sup> /TLS	Prelude 24 XL <sup>2</sup> /TLS Prelude 24 Sixty <sup>2</sup> XL <sup>2</sup> /TLS	Prelude 15 15 TL/XL <sup>2</sup> Interlude HRC XL <sup>2</sup> Silhouette XL <sup>2</sup>	Prelude 24 XL <sup>2</sup> /TLS Prelude 24 Sixty <sup>2</sup> XL <sup>2</sup> /TLS

**Colour** Global White

## Sustainability



77



A



EN 13964 / E1

## Acoustics



EN ISO 354  
& EN ISO 11654



EN ISO 10848-2  
& EN ISO 717-1



EN ISO 140-3  
& EN ISO 717-1

	$\alpha_w$	D <sub>nfw</sub>	R <sub>w</sub>	Class	Hz $\alpha_p$							
					NRC	125	250	500	1000	2000	4000	
Board, Tegular, MicroLook 90 (15mm)	<b>0.90(H)</b>	-	7 dB	A	0.90	0.35	0.75	1.00	0.80	0.90	0.95	
Board, Tegular, MicroLook 90 (20mm)	<b>0.95(H)</b>	-	-	A	0.95	0.40	0.80	1.00	0.85	1.00	1.00	
Vector	<b>1.00(H)</b>	-	-	A	0.95	0.35	0.80	1.00	0.90	1.00	1.00	

## Fire Reaction



EEA Euroclass A2-s1, d0  
EN 13501-1

## Performances & Features



87%



95% RH



30 Year  
System  
Guarantee



$\lambda=0.032$   
W/m K  
EN 12667  
& ISO 8301



1.5 Kg/m<sup>2</sup> (15mm)  
2.0 Kg/m<sup>2</sup> (20mm)  
2.8 Kg/m<sup>2</sup> (22mm)



BIM  
READY

## Custom Options



Dimensions



## Neeva

The smooth laminated finish of the Neeva products combines Class A sound absorption and aesthetics.

## Key Features

- Excellent sound absorption: up to 1.00  $\alpha_w$
- High light reflectance: 82%
- Fibre glass fleece on the back to add strength
- Ideal for open spaces, call centres and libraries

## Edge Detail Board

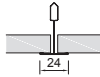

**Thickness (mm)** 15 / 18

**Modules (mm)**  
 600 x 600 x 15 ..... 2691M  
 1200 x 600 x 18 ..... 2406M

**Suspension Systems**  
 Prelude 24 XL<sup>2</sup> / TLS  
 Prelude 24 CR / TLS  
 Prelude 24 Sixty<sup>2</sup> XL<sup>2</sup> / TLS

**Colour** Global White

**Sustainability**

  
 20





  
 A

  
 EN 13964 / E1

**Acoustics**

  
EN ISO 354 & EN ISO 11654

  
EN ISO 10848-2 & EN ISO 717-1

  
EN ISO 140-3 & EN ISO 717-1

	$\alpha_w$	D <sub>nfw</sub>	R <sub>w</sub>	Class	NRC	Hz $\alpha_p$						
						125	250	500	1000	2000	4000	
Board (15mm)	1.00	-	7 dB	A	0.95	0.40	0.90	1.00	0.90	1.00	1.00	
Board (18mm)	1.00	24 dB	-	A	0.95	0.40	0.85	1.00	0.90	1.00	0.95	

**Fire Reaction**



**EEA** Euroclass A2-s1, d0  
EN 13501-1

**Performances & Features**

 82%

 95% RH





  $\lambda=0.033$  W/m K  
EN 12667 & ISO 8301

 1.2 Kg/m<sup>2</sup> Board (15mm)  
1.3 Kg/m<sup>2</sup> Board (18mm)





**Custom Options**



Dimensions



## Plain

The smooth and white surface of Plain meet today's trends for cleaner finishes whilst maximising light reflectance.



## Key Features

- High light reflectance: 87%
- Energy savings due to high level of light reflectance
- Good sound attenuation
- Ideal for retail environments and canteens

Edge Detail	Board	Tegular	MicroLook
<b>Thickness (mm)</b>	15	15	15
<b>Modules (mm)</b>	600 x 600 ..... 9587M 1200 x 600 ..... 9588M	600 x 600 ..... 9589M	600 x 600 ..... 9590M
<b>Suspension Systems</b>	Prelude 24 XL <sup>2</sup> / TLS Prelude 24 Sixty <sup>2</sup> XL <sup>2</sup> / TLS	Prelude 24 XL <sup>2</sup> / TLS Prelude 24 Sixty <sup>2</sup> XL <sup>2</sup> / TLS	Prelude 15 TL/ XL <sup>2</sup> Interlude HRC XL <sup>2</sup>
<b>Colour</b>	Global White		

## Sustainability



39



A+ / A<sup>1</sup>



EN 13964 / E1

## Acoustics



EN ISO 354  
& EN ISO 11654



EN ISO 10848-2  
& EN ISO 717-1

	$\alpha_w$	D <sub>nfw</sub>	Class	NRC	Hz $\alpha_p$					
					125	250	500	1000	2000	4000
Board, Tegular, MicroLook	0.20(L)	35 dB	E	0.20	0.30	0.25	0.15	0.15	0.25	0.30

## Fire Reaction



EEA Euroclass A2-s1, d0  
EN 13501-1

## Performances & Features



87%



95% RH



$\lambda=0.060$   
W/m K  
EN 12667  
& ISO 8301



3.5 Kg/m<sup>2</sup>





## Fine Fissured

The non-directional Fine Fissured surface provides a solution for providing Class C sound absorption.

## Key Features

- ✓ Good sound absorption: 0.60(H)  $\alpha_w$
- ✓ Ideal for storage facilities, corridor and warehouses

Edge Detail	Board	Tegular	MicroLook
<b>Thickness (mm)</b>	15	15	15
<b>Modules (mm)</b>	600 x 600 ..... 9121M 1200 x 600 ..... 9120M	600 x 600 ..... 9122M	600 x 600 ..... 9202M
<b>Suspension Systems</b>	Prelude 24 XL <sup>2</sup> / TLS Prelude 24 Sixty <sup>2</sup> XL <sup>2</sup> / TLS	Prelude 24 XL <sup>2</sup> / TLS Prelude 24 Sixty <sup>2</sup> XL <sup>2</sup> / TLS	Prelude 15 TL / XL <sup>2</sup> Interlude HRC XL <sup>2</sup>
<b>Colour</b>	Global White		

## Sustainability



39-51



A+



EN 13964 / E1

## Acoustics



EN ISO 354  
& EN ISO 11654



EN ISO 21040-9  
& EN ISO 717-1

	$\alpha_w$	D <sub>nfw</sub>	Class	NRC	Hz $\alpha_p$					
					125	250	500	1000	2000	4000
Board, Tegular, MicroLook	0.60(H)	34 dB	C	0.60	0.40	0.40	0.55	0.75	0.75	0.75

## Fire Reaction



EEA Euroclass A2-s1, d0  
EN 13501-1

## Performances & Features



85%



95% RH



$\lambda=0.060$   
W/m K  
EN 12667  
& ISO 8301



3.4 Kg/m<sup>2</sup>



30 Year  
System  
Guarantee



BIM  
READY

## Custom Options



Dimensions



## Colortone

Available in Dune eVo, Fine Fissured or Neeva surfaces depending on your acoustic requirements, the Colortone Range offers a simple way to add darker tones and more depth to your ceilings. Combine the black colour option with Prelude 24 black grid for the perfect solution for cinema applications and other dark spaces.

# Colortone Neeva



## Key Features

- Excellent acoustical absorption:  $1.00 \alpha_w$
- Available in Black
- Ideal cafeterias, cinemas and theatres

## Edge Detail Board

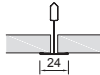

**Thickness (mm)** 15

**Modules (mm)**  
 600 x 600 ..... 2695DBK  
 1200 x 600 ..... 2696MBK

**Suspension Systems** Prelude 24 XL<sup>2</sup> / TLS  
 RAL 9005

**Colour** Black (BK)

**Sustainability**

  
 20

  
 A

  
 EN 13964 / E1

**Acoustics**

  
EN ISO 354 & EN ISO 11654

  
EN ISO 10848-2 & EN ISO 717-1

  
EN ISO 140-3 & EN ISO 717-1

	$\alpha_w$	D <sub>nfw</sub>	R <sub>w</sub>	Class	NRC	Hz $\alpha_p$					
						125	250	500	1000	2000	4000
Board	1.00	-	7 dB	A	0.95	0.40	0.90	1.00	0.90	1.00	1.00

**Fire Reaction**



**EEA Euroclass A1**  
 EN 13501-1

**Performances & Features**



95% RH





30 Year System Guarantee



$\lambda=0.033$   
 W/m K  
 EN 12667 & ISO 8301



1.2 Kg/m<sup>2</sup>



BIM READY

# Colortone Fine Fissured



## Key Features

- Available in Black
- Ideal cafeterias, cinemas and theatres

## Edge Detail Board

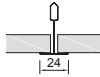

**Thickness (mm)** 15

**Modules (mm)** 600 x 600 ..... 9121DBK

**Suspension Systems** Prelude 24 XL<sup>2</sup> / TLS  
RAL 9005

**Colour** Black (BK)

**Sustainability**



51





A



EN 13964 / E1

**Acoustics**



EN ISO 354  
& EN ISO 11654



EN ISO 10848-2  
& EN ISO 717-1

	Hz $\alpha_p$									
	$\alpha_w$	$D_{nfw}$	Class	NRC	125	250	500	1000	2000	4000
Board	0.60(H)	36 dB	C	0.60	0.40	0.40	0.55	0.75	0.75	0.75

**Fire Reaction**





**EEA Euroclass A2-s1, d0**  
EN 13501-1

**Performances & Features**



95% RH







30 Year System Guarantee



$\lambda=0.060$   
W/m K  
EN 12667  
& ISO 8301



3.4 Kg/m<sup>2</sup>



BIM READY

# Colortone Dune eVo

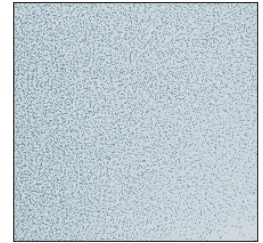

## Key Features

- 3 edge details available
- Available in Platinum
- Ideal cafeterias, cinemas and theatres

Edge Detail	Board	Tegular	MicroLook 90
<b>Thickness (mm)</b>	15	15	15
<b>Modules (mm)</b>	600 x 600 ..... 5460MPN 1200 x 600 ..... 5461MPN	600 x 600 ..... 5462MPN	600 x 600 ..... 5464MPN
<b>Suspension Systems</b>	Prelude 24 XL <sup>2</sup> / TLS	Prelude 24 XL <sup>2</sup> / TLS	Prelude 15 TL / TLS
<b>Colour</b>	Platinum (PN)		

## Sustainability



44



A



EN 13964 / E1

## Acoustics



EN ISO 354  
& EN ISO 11654



EN ISO 10848-2  
& EN ISO 717-1

	Hz $\alpha_p$									
	$\alpha_w$	D <sub>nfw</sub>	Class	NRC	125	250	500	1000	2000	4000
Board, Tegular, MicroLook 90	0.60(H)	34 dB	C	0.50	0.40	0.40	0.60	0.55	0.55	0.50

## Fire Reaction



EEA Euroclass A2-s1, d0  
EN 13501-1

## Performances & Features



Up to 72%



95% RH



$\lambda=0.060$   
W/m K  
EN 12667  
& ISO 8301



3.6 Kg/m<sup>2</sup>





## Specific solutions for specific areas

- // Bioguard Plain
- // Bioguard Acoustic (ISO 5)
- // Hygiene (ISO 4)
- // Clean Room FL (ISO 5)
- // Hydroboard ( $\leq 100\%$  RH)
- // Ceramaguard (100% RH)
- // Aquabloc

### Bioguard for healthcare environments

The Bioguard treatment applied to mineral tiles provides good clean-ability and resistance to disinfectants as well as anti-microbial and clean room performance.

### Corrosion resistant grid

Our corrosion resistant grid is galvanised and organically coated in accordance with Durability – Class of Exposure Class C (EN 13964: table 8). In addition, it has been tested for salt spray corrosion in accordance with EN ISO 9227 and achieved over 700 hours resistance.

### Hygiene for clean rooms and kitchens

Suitable for high pressure water cleaning and providing high sound absorption the product is particularly adapted to greasy and noisy environments such as kitchens. The ISO 4 performance makes the product suitable for clean rooms.

### Clean Room FL for clean rooms

The surface and edges are sealed with a polyester film which doesn't attract dust and can be washed regularly. The product is suitable for ISO 5 clean rooms.

### Hydroboard for higher humidity areas

For solutions requiring higher than standard resistance to humidity, Hydroboard is stable at humidities up to 100%.

### Ceramaguard for high humidity areas

With a true 100% RH resistance, Ceramaguard is the ideal solution for swimming pools, shower areas, toilets and areas subject to extremes of temperature and humidity.

***Note:** For swimming pools and other potentially aggressive environments, there are many variables in the overall design that can impact the suitability of installed materials.*



# Focus on Bioguard solutions

Bioguard is a special treatment applied to Zentia mineral tiles which provides protection against bio-contamination.

Bioguard solutions have the following benefits:

- // Good cleanability and resistance to disinfectants
- // They provide clean room performance
- // They prevent the build-up of bacteria, mould and yeast
- // There is no spread of chemicals in the air
- // They are harmless for people, animals and plants
- // They are effective during the lifetime of the ceiling as long as the surface is intact
- // The very smooth surface limits the accumulation of dust and micro-organisms

Bioguard Acoustic Board is available with fully painted edges to provide the best guarantee for a clean room environment.





Protection against biocontamination



ISO Clean room

Resistance to disinfectants

	Mineral		Grid
	Bioguard Plain	Bioguard Acoustic	Clean Room Grid
HTM 60 Category	Category 2, 3, 4, 5, 6	Category 2, 3, 4, 5, 6	Category 2, 3, 4, 5, 6
Particle Emission Class <sup>1</sup>	ISO 5	ISO 5	ISO 4
Material	Mineral	Mineral	Aluminium
 Cleaning	Washable with a damp sponge	Sponge damp rough texture (medium pressure)	Washable with a damp sponge
 Resistance to Disinfectants	Quaternary Ammonium, Hydrogen Peroxide, Chlorine		

<sup>1</sup>Tested against ISO 14644-1

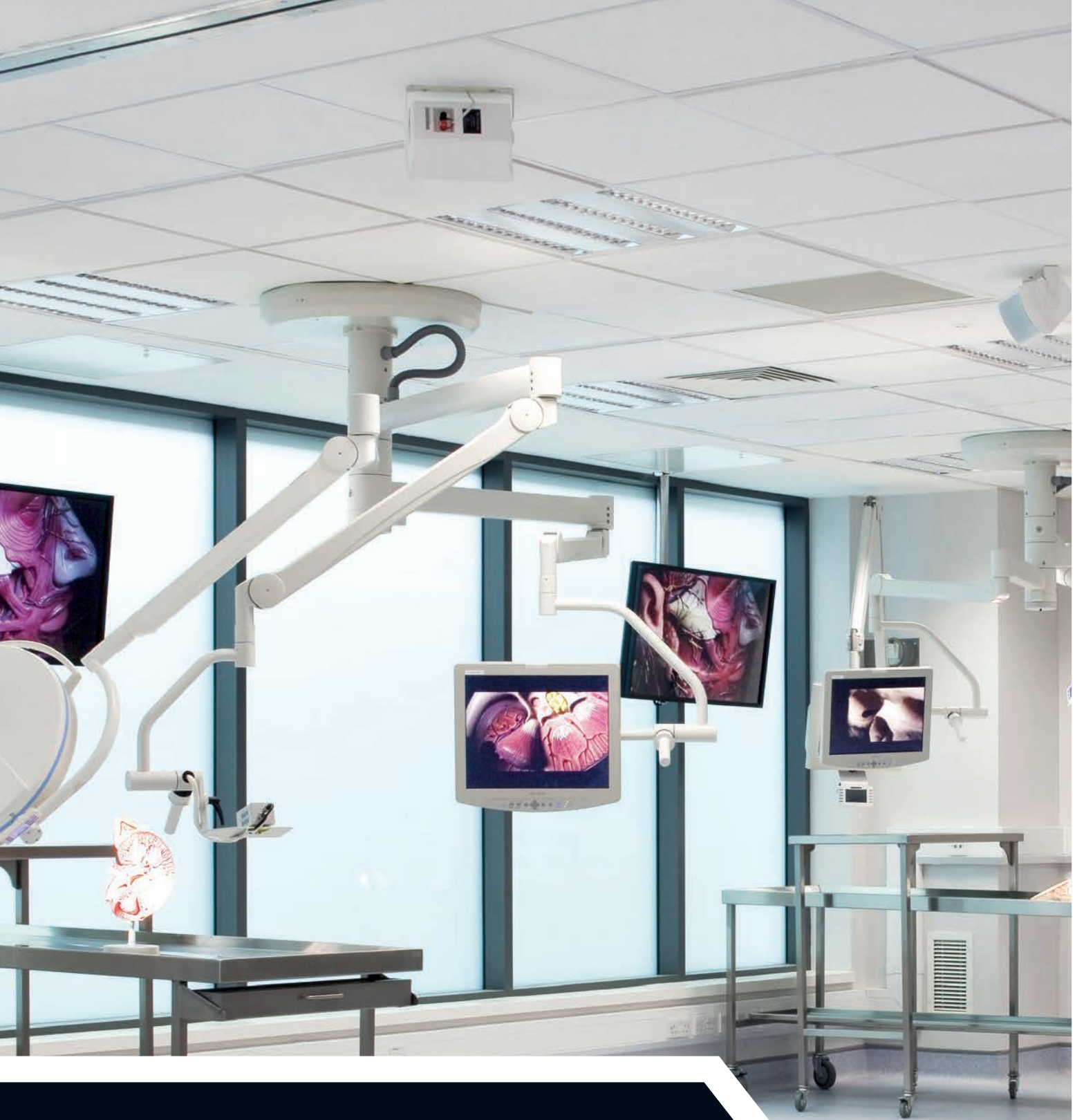



## Bioguard Plain

Bioguard Plain combines excellent cleanability and resistance to disinfectants. Along with its antimicrobial performance it is an ideal solution for healthcare environments.

## Key Features

- /// Available in Plain surface with enhanced water repellency
- /// High light reflectance: 87%
- /// Washable
- /// Safe use with disinfectants
- /// ISO 5
- /// Ideal for healthcare environments with average to severe risk of infection

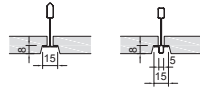
Edge Detail	Board	Tegular	MicroLook
			
<b>Thickness (mm)</b>	15	15	15
<b>Modules (mm)</b>	600 x 600 ..... 2221M 1200 x 600 ..... 2222M	600 x 600 ..... 2223M	600 x 600 ..... 2224M
<b>Suspension Systems</b>	Prelude 24 XL <sup>2</sup> / TLS Prelude 24 Corrosive Resistant Clean Room 24	Prelude 24 XL <sup>2</sup> / TLS Clean Room 24	Prelude 15 TL / XL <sup>2</sup> Interlude HRC XL <sup>2</sup>

**Colour** Global White

## Sustainability



39



A+/A<sup>1</sup>



EN 13964 / E1

<sup>1</sup>Depends on thickness, edge detail and size of tile.

## Acoustics



EN ISO 354  
& EN ISO 11654



EN ISO 10848-2  
& EN ISO 717-1



EN ISO 140-3  
& EN ISO 717-1

	$\alpha_w$	D <sub>nfw</sub>	R <sub>w</sub>	Class	NRC	Hz $\alpha_p$						
						125	250	500	1000	2000	4000	
Board, Tegular, MicroLook	0.20(L)	35 dB	19 dB	E	0.20	0.40	0.25	0.15	0.15	0.20	0.30	

## Fire Reaction



EEA Euroclass A2-s1, d0  
EN 13501-1

## Performances & Features



87%



95% RH



ISO 5



ISO 14644-1



$\lambda=0.060$   
W/m K  
EN 12667  
& ISO 8301



3.6 Kg/m<sup>2</sup>





## Bioguard Acoustic (ISO 5)

Bioguard Acoustic combines excellent cleanability, resistance to disinfectants and sound absorption. Along with its antimicrobial performance it is an ideal solution for healthcare environments.

## Key Features

- Safe use with disinfectants
- Enhanced water repellency: washable
- Enhanced sound absorption of 0.60(H)  $\alpha_w$
- ISO 5
- Ideal for healthcare environments with average to severe risk of infection

Edge Detail	Board	Tegular	MicroLook
Thickness (mm)	17	17	17
Modules (mm)	600 x 600 ..... 2549M 1200 x 600 ..... 2550M 600 x 600 } with painted edges ..... 2703M 1200 x 600 } ..... 2704M	600 x 600 ..... 2551M	600 x 600 ..... 2552M
Suspension Systems	Prelude 24 XL <sup>2</sup> / TLS Prelude 24 Corrosive Resistant Clean Room 24	Prelude 24 XL <sup>2</sup> / TLS Clean Room 24	Prelude 15 TL / XL <sup>2</sup> Interlude HRC XL <sup>2</sup>

Colour Global White

## Sustainability



41



A+



EN 13964 / E1

## Acoustics



EN ISO 354  
& EN ISO 11654



EN ISO 10848-2  
& EN ISO 717-1



EN ISO 140-3  
& EN ISO 717-1

Hz  $\alpha_p$

	$\alpha_w$	D <sub>nfw</sub>	R <sub>w</sub>	Class	NRC	125	250	500	1000	2000	4000
Board, Tegular, MicroLook	0.60(H)	36 dB	18 dB	C	0.60	0.35	0.40	0.50	0.70	0.85	0.90

## Fire Reaction



EEA Euroclass A2-s1, d0  
EN 13501-1

## Performances & Features



85%



95% RH



ISO 5

ISO 14644-1



30 Year System Guarantee



$\lambda=0.060$   
W/m K  
EN 12667  
& ISO 8301



4.5 Kg/m<sup>2</sup>



BIM READY

## Custom Options



Dimensions



## Hygiene (ISO 4)

Hygiene offers a Class A sound absorption, washability and hygiene performances.

## Key Features

- ✔ Suitable for high pressure water cleaning
- ✔ Excellent sound absorption 0.95  $\alpha_w$
- ✔ ISO 4 with Clean Room grid
- ✔ Ideal for commercial kitchens and healthcare environments

## Edge Detail Board

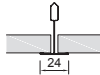

**Thickness (mm)** 18

**Modules (mm)**  
 600 x 600 ..... 9702M  
 1200 x 600 ..... 9703M

**Suspension Systems**  
 Prelude 24 XL<sup>2</sup> / TLS  
 Prelude 24 Corrosive Resistant  
 Clean Room 24 (to achieve ISO4)

**Colour** Global White

**Sustainability**



20





A



EN 13964 / E1

**Acoustics**



EN ISO 354  
& EN ISO 11654

	Hz $\alpha_p$								
	$\alpha_w$	Class	NRC	125	250	500	1000	2000	4000
Board	0.95	A	0.95	0.40	0.85	0.90	0.90	0.95	0.90

**Fire Reaction**



**EEA** Euroclass A2-s1, d0  
EN 13501-1

**Performances & Features**



82%



95% RH



ISO 4



ISO 14644-1



<sup>1</sup>



30 Year System Guarantee



$\lambda=0.033$   
W/m K  
EN 12667 & ISO 8301



1.3 Kg/m<sup>2</sup>









BIM READY

**Custom Options**



Dimensions

<sup>1</sup> The application must be in the form of a fan spray of 30° angle and not a high pressure 'cutting jet'. The suggested minimum distance between the nozzle and the ceiling tile should not be less than 300 mm and the angle of projection should be 45°. Hygiene should be installed with Prelude 24 Corrosive Resistant grid and be clipped for high pressure water cleaning. Cleaning recommended twice a year.



## Clean Room FL (ISO 5)

Clean Room FL features a special polyester film facing providing excellent ISO clean room performance making it an ideal solution for clean room and computer environments, especially in combination with Zentia Clean Room 24 grid system.



## Key Features

- ISO 5
- Does not attract dust
- Adapted to regular washing
- Ideal for computer and clean room environments

## Edge Detail Board

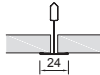

**Thickness (mm)** 15

**Modules (mm)**  
 600 x 600 ..... 9527M  
 1200 x 600 ..... 9529M

**Suspension Systems**  
 Prelude 24 XL<sup>2</sup> / TLS  
 Prelude 24 Corrosive Resistant  
 Clean Room 24

**Colour** Global White

**Sustainability**

  
 39



  
 A+

  
 EN 13964 / E1

**Acoustics**

  
EN ISO 354 & EN ISO 11654

  
EN ISO 21040-9 & EN ISO 717-1

	$\alpha_w$	$D_{nfw}$	Class	NRC	Hz $\alpha_p$					
					125	250	500	1000	2000	4000
Board	0.15	36 dB	E	0.10	0.25	0.15	0.10	0.10	0.15	0.25

**Fire Reaction**





**EEA** Euroclass A2-s1, d0  
 EN 13501-1

**Performances & Features**

 78%

 95% RH

 ISO 5









  $\lambda=0.060$   
W/m K  
EN 12667 & ISO 8301

 5.3 Kg/m<sup>2</sup>











## Hydroboard ( $\leq 100\%$ RH)

Hydroboard can resist permanent RH up to 95% and temporary conditions of up to 100% RH. Install with Zentia Prelude 24 Corrosive Resistant grid system for higher humidity areas.

## Key Features

- Stable at humidity levels of up to 100% RH
- Can be installed in temperatures ranging from 0°C to 40°C
- High acoustic absorption up to 0.95  $\alpha_w$
- Ideal for WC, shower areas and hydrotherapy rooms. Should be installed on Corrosive Resistant grid

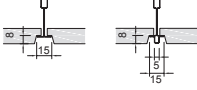
Edge Detail	Board	Tegular	Microlook 90
			
<b>Thickness (mm)</b>	15	15	15
<b>Modules (mm)</b>	600 x 600 ..... 3687M 1200 x 600 ..... 3688M	600 x 600 ..... 3689M	600 x 600 ..... 3691M
<b>Suspension Systems</b>	Prelude 24 Corrosive Resistant TLS	Prelude 24 XL <sup>2</sup> / TLS Prelude 24 Corrosive Resistant Prelude 24 Sixty <sup>2</sup> XL <sup>2</sup> / TLS	Prelude 15 TL / XL <sup>2</sup> Interlude HRC XL <sup>2</sup> Silhouette XL <sup>2</sup>

**Colour** Global White

## Sustainability



20



A



EN 13964 / E1

## Acoustics



EN ISO 354  
& EN ISO 11654



EN ISO 21040-9  
& EN ISO 717-1

	$\alpha_w$	$D_{nfw}$	Class	NRC	Hz $\alpha_p$					
					125	250	500	1000	2000	4000
Board	0.95	22 dB	A	0.90	0.35	0.80	1.00	0.85	1.00	1.00
Tegular 24 Tegular 15	0.90	22 dB	A	0.85	0.40	0.75	0.85	0.85	0.95	0.95

## Fire Reaction



Euroclass A2-s1, d0  
EN 13501-1

## Performances & Features



82%



≤100% RH



1.2 Kg/m<sup>2</sup> Board

2.5 Kg/m<sup>2</sup> Tegular 90,  
MicroLook 90





## Ceramaguard (100% RH)

With its unique high density mineral composition, Ceramaguard is steam resistant and will retain its physical integrity even when subjected to 100% RH. It also features a washable finish and is lightly fissured to provide acoustic performance.

## Key Features

- ✓ 100% RH resistance
- ✓ Durable, washable and scrubbable
- ✓ Resistant to growth of mould, mildew and bacteria
- ✓ Good balance between sound attenuation and absorption
- ✓ Ideal for swimming pools, locker rooms, shower areas and indoor parking areas

Edge Detail	Board
-------------	-------

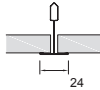

<b>Thickness (mm)</b>	15
-----------------------	----

<b>Modules (mm)</b>	600 x 600 ..... 607M
---------------------	----------------------

<b>Suspension Systems</b>	Prelude 24 XL <sup>2</sup> / TLS Prelude 24 Corrosive Resistant <sup>1</sup> Clean Room 24	<sup>1</sup> Ceramaguard must be installed on Prelude 24 Corrosive Resistant grid where humidity regularly exceeds 95% RH. Ceramaguard may need to have Main Runners at 600 mm centres due to increased weight in high humidity conditions.
---------------------------	--	---

<b>Colour</b>	Global White
---------------	--------------

<b>Sustainability</b>	 37		 A+	 EN 13964 / E1
-----------------------	--------	--	--------	-------------------

<b>Acoustics</b>	 EN ISO 354 & EN ISO 11654	 EN ISO 21040-9 & EN ISO 717-1								
	$\alpha_w$	$D_{nfw}$	Class	NRC	Hz $\alpha_p$					
					125	250	500	1000	2000	4000
Board	0.55(MH)	39 dB	D	0.60	0.25	0.30	0.50	0.80	0.85	0.75

<b>Fire Reaction</b>	 EEA Euroclass A2-s1, d0 EN 13501-1
----------------------	---

<b>Performances &amp; Features</b>	79%	100% RH			
	 $\lambda=0.067$ W/m K EN 12667 & ISO 8301	 7.3 Kg/m <sup>2</sup> 20 Kg/m <sup>2</sup> if wet			



## Aquabloc

Aquabloc is a hydrated calcium silicate ceiling tile offering 100% RH performance and is suitable for use in areas subject to extremes of humidity and temperature.

## Key Features

- // 100% RH resistance
- // Suitable for extreme temperatures and high humidity conditions
- // Resistant to damage
- // Ideal for spas and water parks

## Edge Detail Board

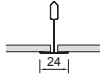

**Thickness (mm)** 6

**Modules (mm)** 600 x 600 ..... 2100M

**Suspension Systems** Prelude 24 XL<sup>2</sup> / TLS  
Prelude 24 Corrosive Resistant<sup>1</sup>  
Clean Room 24

**Colour** Global White

## Sustainability



30



EN 13964 / E1

## Acoustics



EN ISO 354 & EN ISO 11654



EN ISO 21040-9 & EN ISO 717-1

	$\alpha_w$	$D_{nfw}$	Class	NRC	Hz $\alpha_p$					
					125	250	500	1000	2000	4000
Board	0.10(L)	37 dB	-	0.10	0.25	0.15	0.10	0.10	0.10	0.05

## Fire Reaction



EEA Euroclass A1  
EN 13501-1

## Performances & Features



84%



100% RH



30 Year System Guarantee



8.0 Kg/m<sup>2</sup>



BIM READY

While this product is suitable for high humidity environments, it is not suitable to be fitted directly over a swimming pool.



## DecoMesh

Use Zentia's DecoMesh to achieve an industrial and contemporary look. Installed on Prelude 15 and Prelude 24 suspension systems, DecoMesh is an ideal choice for transport hubs, renovation projects wanting a modern touch and in general spaces with large ceiling areas.



## Key Features

- // Contemporary design aesthetic
- // Available in a range of colours
- // Available as Board, Tegular and MicroLook edge detail
- // Suitable for transport hubs, office areas and large lobby areas etc.
- // Compatible with standard grid systems
- // Six mesh patterns offering a range of design and effect options

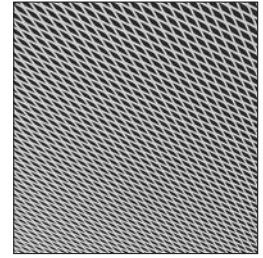

## Mesh Patterns

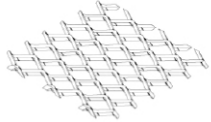

**RB25**  
Long diagonal: 16mm  
Short diagonal: 8mm  
Open area: 50%



**RB35**  
Long diagonal: 28mm  
Short diagonal: 10mm  
Open area: 58%

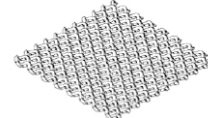

**KD100**  
Long diagonal: 6mm  
Short diagonal: 4.5mm  
Open area: 36%

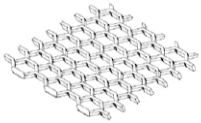

**E15**  
Long diagonal: 15mm  
Short diagonal: 6.5mm  
Open area: 45%



**R10**  
Long diagonal: 10mm  
Short diagonal: 5.8mm  
Open area: 45%



**R28**  
Long diagonal: 28mm  
Short diagonal: 14mm  
Open area: 74%

Edge Detail	Board	Tegular	MicroLook
<b>Modules (mm)</b>	<p><b>RB25</b> 600 x 600 ..... MRB25B66 1200 x 600 ..... MRB25B126</p> <p><b>RB35</b> 600 x 600 ..... MRB35B66 1200 x 600 ..... MRB35B126</p> <p><b>KD100</b> 600 x 600 ..... MKD100B66 1200 x 600 ..... MKD100B126</p> <p><b>E15</b> 600 x 600 ..... ME15B66 1200 x 600 ..... ME15B126</p> <p><b>R10</b> 600 x 600 ..... MR10B66 1200 x 600 ..... MR10B126</p> <p><b>R28</b> 600 x 600 ..... MR28B66 1200 x 600 ..... MR28B126</p>	<p><b>RB25</b> 600 x 600 ..... MRB25T66</p> <p><b>KD100</b> 600 x 600 ..... MKD100T66</p> <p><b>R10</b> 600 x 600 ..... MR10T66</p>	<p><b>RB25</b> 600 x 600 ..... MRB25M66</p> <p><b>KD100</b> 600 x 600 ..... MKD100M66</p> <p><b>R10</b> 600 x 600 ..... MR10M66</p>
<b>Suspension Systems</b>	Prelude 24 TLS Prelude 24 Sixty <sup>2</sup> TLS	Prelude 24 XL <sup>2</sup> / TLS Prelude 24 Sixty <sup>2</sup> XL <sup>2</sup> / TLS	Prelude 15 TL / XL <sup>2</sup>

**Sustainability**



48



A+



EN 13964 / E1

**Fire Reaction**



Euroclass A2-s1, d0  
EN 13501-1

**Performances & Features**



95% RH



RB25: 3.95kg/m<sup>2</sup> E15: 3.15kg/m<sup>2</sup>  
RB35: 4.80kg/m<sup>2</sup> R10: 3.90kg/m<sup>2</sup>  
KD100: 4.15kg/m<sup>2</sup> R28: 3.40kg/m<sup>2</sup>



**30 Year**  
System  
Guarantee

**Custom Options**



Dimensions



Colours

**Standard Colours (RAL)**

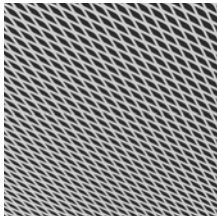

White (9003)

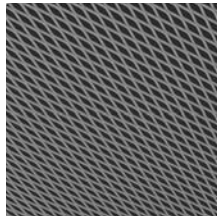

Aluminium (9006)

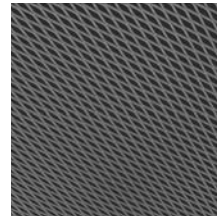

Grey (9007)



Black (9005)

**Non-standard Colours (RAL)**

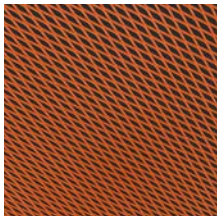

Orange (2003)

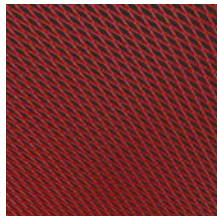

Red (3020)

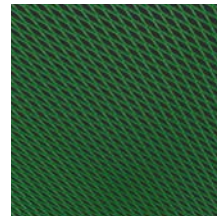

Green (6037)

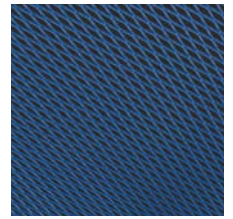

Blue (5015)

**Accessories**

Hold down clip | BPOCHC



## Floating ceiling solutions

- // Axiom C Canopy
- // Axiom C Canopy SL2 Planks
- // Axiom KE Canopy
- // Axiom Circle & Curved Canopy
- // Axiom L Canopy
- // Baffles
- // Canopy

# Benefits of floating ceilings



## Flexible

Open up an almost endless range of dramatic design possibilities that can be suspended from any soffit. Get quick and simple 'Go where you need, do what you want' ceilings that can be easily relocated when needs change.

## Great acoustics

Because all faces and edges are exposed, they can provide a greater sound absorption surface than continuous ceilings.

## Light and bright

Specially engineered surfaces reflect up to 87% of light back to improve illumination, making spaces more bright, comfortable and cutting energy bills.

## Modern

Floating ceilings introduce new shapes, add depth, scale and rhythm to internal spaces, creating a new, trendy aesthetic for modern building designers.

## Green

Our canopies and baffles help create a more sustainable interior, contributing to a better indoor air quality, acoustical comfort and supporting high mass low energy construction. By improving light reflection they can also cut lighting energy use.

# Meeting your acoustical requirements

Floating Ceilings can provide greater sound absorption than a traditional wall to wall ceiling of the same visible surface area because the sound is absorbed from both the front and back surfaces of the canopy.

Floating Ceilings installed in a typical 'lively' space will help reduce the reverberation time.

Sabine per unit is preferred to characterise the absorption provided by an individual space absorber, such as canopies in:

- // Open spaces, open plan offices, retail outlets
- // Corridors / lobbies

Factors that may affect the installed acoustical performance relative to the published results are:

- // Size of canopies
- // Number of canopies and their layout
- // Suspension distance below a finished ceiling
- // Location of canopy
- // Ceiling tile selection



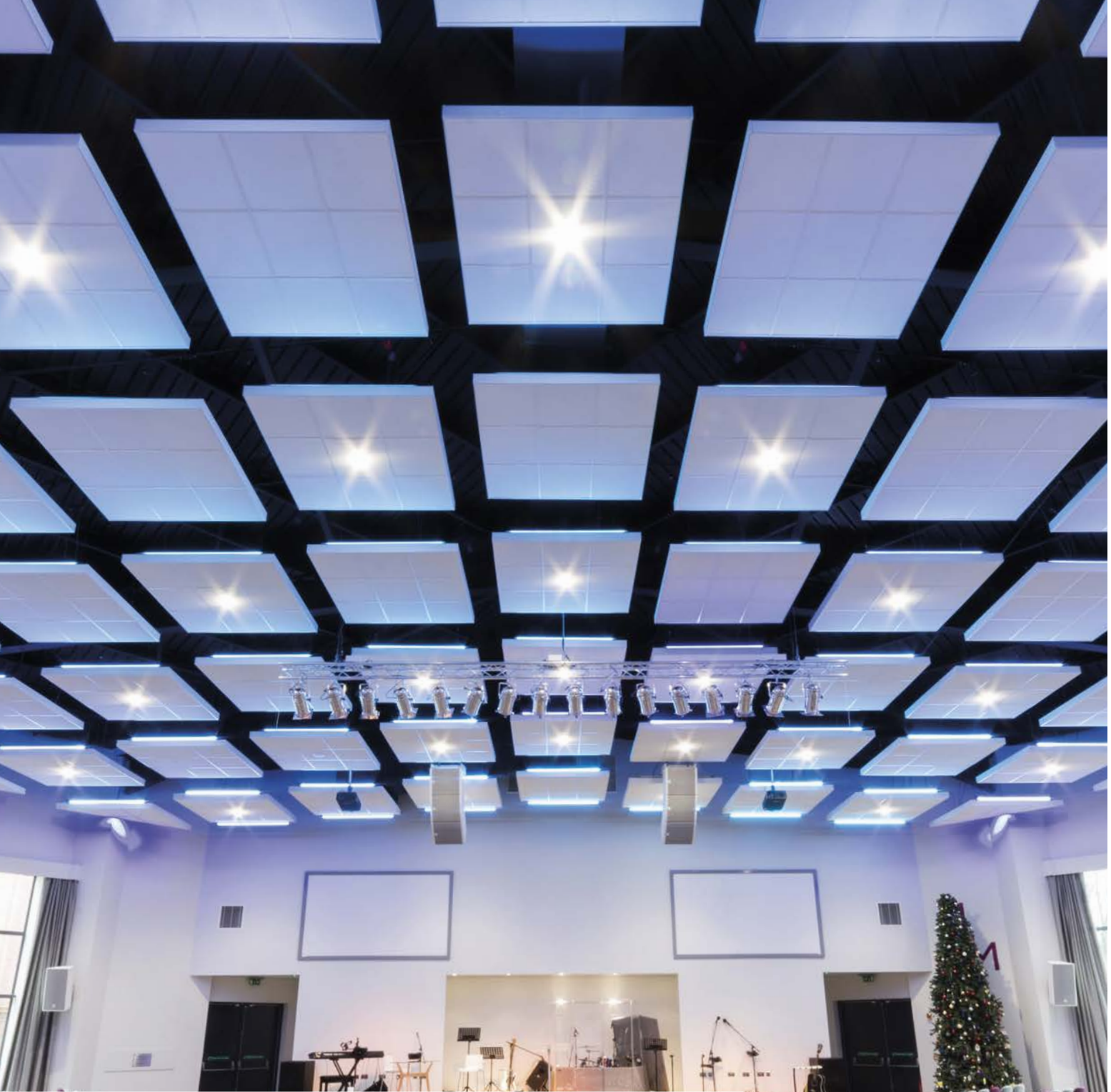

## Axiom C Canopy

Floating ceiling suspension kits using 112mm Axiom Profileframe to create ceiling canopies.

## Key Features

Ceiling tiles are **NOT** included in this kit

- // Made-to-measure components and accessories all in a single box, ready-to-install for quick and easy installation
- // Available in 10 standard modules with Prelude 15 or 24 grid for installation with full size ceiling tiles. Custom dimensions available on request
- // Pre-fabricated corner sections for high quality corner detailing
- // Ideal for reception areas, meeting areas circulation spaces and retail

Suspension System	Axiom C Canopy – 15mm XL <sup>2</sup>	Axiom C Canopy – 24mm XL <sup>2</sup>
<b>Modules (mm)</b>	1200 x 1200 ..... AX 22 G15 1800 x 1200 ..... AX 32 G15 1800 x 1800 ..... AX 33 G15 2400 x 1200 ..... AX 42 G15 2400 x 1800 ..... AX 43 G15 2400 x 2400 ..... AX 44 G15 3000 x 1200 ..... AX 52 G15 3000 x 1800 ..... AX 53 G15 3000 x 2400 ..... AX 54 G15 3000 x 3000 ..... AX 55 G15	1200 x 1200 ..... AX 22 G24 1800 x 1200 ..... AX 32 G24 1800 x 1800 ..... AX 33 G24 2400 x 1200 ..... AX 42 G24 2400 x 1800 ..... AX 43 G24 2400 x 2400 ..... AX 44 G24 3000 x 1200 ..... AX 52 G24 3000 x 1800 ..... AX 53 G24 3000 x 2400 ..... AX 54 G24 3000 x 3000 ..... AX 55 G24
<b>System Width (mm)</b>	15	24
<b>Tile Compatibility</b>	MicroLook / MicroLook 90 / MicroLook BE	Board / Tegular / Tegular 90 / Vector

**Sustainability**



A+



E1  
EN 13964

**Fire Reaction<sup>1</sup>**



EEA Euroclass A2-s1, d0  
EN 13501-1

<sup>1</sup>For the Canopy kit

**Performances & Features**









**30 Year  
System  
Guarantee**

Other performances values will depend upon the infill tile used with the Axiom C Canopy

**Custom Options**



Dimensions



Shapes



Service  
Integration

## Installation Layout

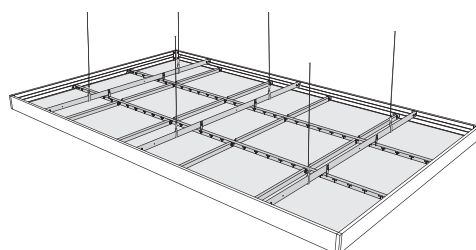
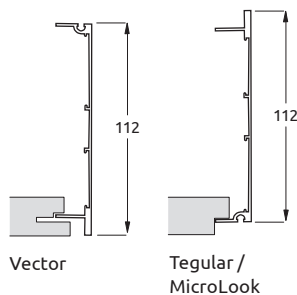

	3000	2400	1800	1200
1200	10 tiles	8 tiles	6 tiles	4 tiles
1800	15 tiles	12 tiles	9 tiles	
2400	20 tiles	16 tiles		
3000	25 tiles			



## Axiom C Canopy SL2 Planks

Floating ceiling suspension kits using 112mm Axiom Profile frame to create semi-concealed ceiling canopies.

## Key Features

Ceiling tiles are **NOT** included in this kit

- ✓ Made-to-measure components and accessories all in a single box, ready-to-install for quick and easy installation
- ✓ Available in 6 standard modules with PZ-Bars for installation with full size SL2 ceiling planks. Custom dimensions available on request
- ✓ Pre-fabricated corner sections for high quality corner detailing
- ✓ Ideal for reception areas, meeting areas circulation spaces and retail

### Suspension System **Axiom C Canopy SL2**

<b>Modules (mm)</b>	1800 x 1500.....	AX 36G SL2
	2400 x 1500.....	AX 46G SL2
	3000 x 1500.....	AX 56G SL2
	1800 x 1800.....	AX 33G SL2
	2400 x 1800.....	AX 43G SL2
	3000 x 1800.....	AX 53G SL2

### Tile Compatibility **SL2**

**Sustainability**



A+



EN 13964  
E1

**Fire Reaction<sup>1</sup>**



EEA Euroclass A2-s1, d0  
EN 13501-1

<sup>1</sup>For the Canopy kit

**Performances & Features**









**30 Year System Guarantee**

Other performances values will depend upon the infill tile used with the Axiom C Canopy SL2 Planks

**Custom Options**



Dimensions









Shapes

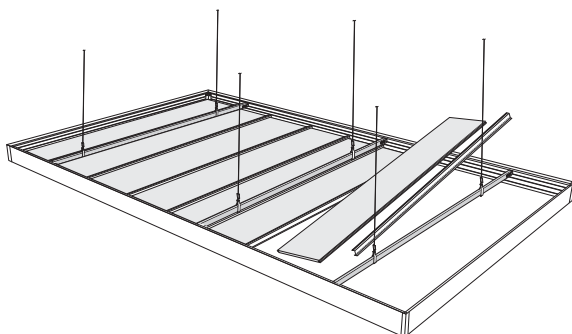
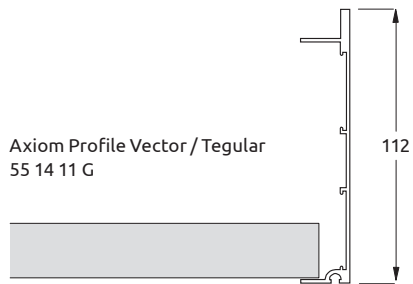

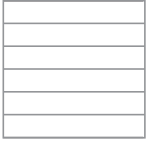
Service Integration

### Installation Layout



	1800	1500
<b>6 planks</b>		
<b>8 planks</b>		
<b>10 planks</b>		





## Axiom KE Canopy

Floating ceiling suspension kits with Axiom Knife Edge Profile for ceiling canopies with a sleek, minimalist appearance.

## Key Features

Ceiling tiles are **NOT** included in this kit

- ✔ Made-to-measure components and accessories all in a single box, ready-to-install for quick and easy installation
- ✔ Available in 10 standard modules with Prelude 15 or 24 grid for installation with full size ceiling tiles. Custom dimensions available on request
- ✔ Pre-fabricated corner sections for high quality corner detailing
- ✔ Ideal for reception areas, meeting areas circulation spaces and retail

Suspension System	Axiom KE Canopy – 15mm XL <sup>2</sup>	Axiom KE Canopy – 24mm XL <sup>2</sup>
<b>Modules (mm)</b>	1200 x 1200 ..... AK 22 G15 1800 x 1200 ..... AK 32 G15 1800 x 1800 ..... AK 33 G15 2400 x 1200 ..... AK 42 G15 2400 x 1800 ..... AK 43 G15 2400 x 2400 ..... AK 44 G15 3000 x 1200 ..... AK 52 G15 3000 x 1800 ..... AK 53 G15 3000 x 2400 ..... AK 54 G15 3000 x 3000 ..... AK 55 G15	1200 x 1200 ..... AK 22 G24 1800 x 1200 ..... AK 32 G24 1800 x 1800 ..... AK 33 G24 2400 x 1200 ..... AK 42 G24 2400 x 1800 ..... AK 43 G24 2400 x 2400 ..... AK 44 G24 3000 x 1200 ..... AK 52 G24 3000 x 1800 ..... AK 53 G24 3000 x 2400 ..... AK 54 G24 3000 x 3000 ..... AK 55 G24
<b>System Width (mm)</b>	15	24
<b>Tile Compatibility</b>	MicroLook / MicroLook 90	Board / Tegular / Tegular 90 / Vector

**Sustainability**



A+



E1  
EN 13964

**Fire Reaction<sup>1</sup>**



EEA Euroclass A2-s1, d0  
EN 13501-1

<sup>1</sup>For the Canopy kit

**Performances & Features**









**30 Year  
System  
Guarantee**

Other performances values will depend upon the infill tile used with the Axiom KE Canopy

**Custom Options**



Dimensions



Shapes



Service  
Integration

**Installation Layout**

**Vector**

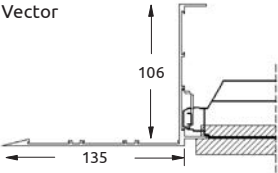

**Tegular / MicroLook / MicroLook 90**

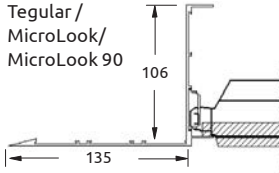

	3000	2400	1800	1200
1200	10 tiles	8 tiles	6 tiles	4 tiles
1800	15 tiles	12 tiles	9 tiles	
2400	20 tiles	16 tiles		
3000	25 tiles			

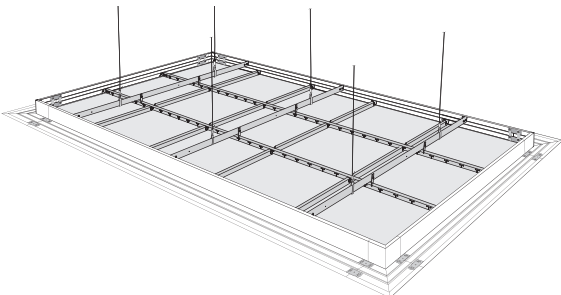

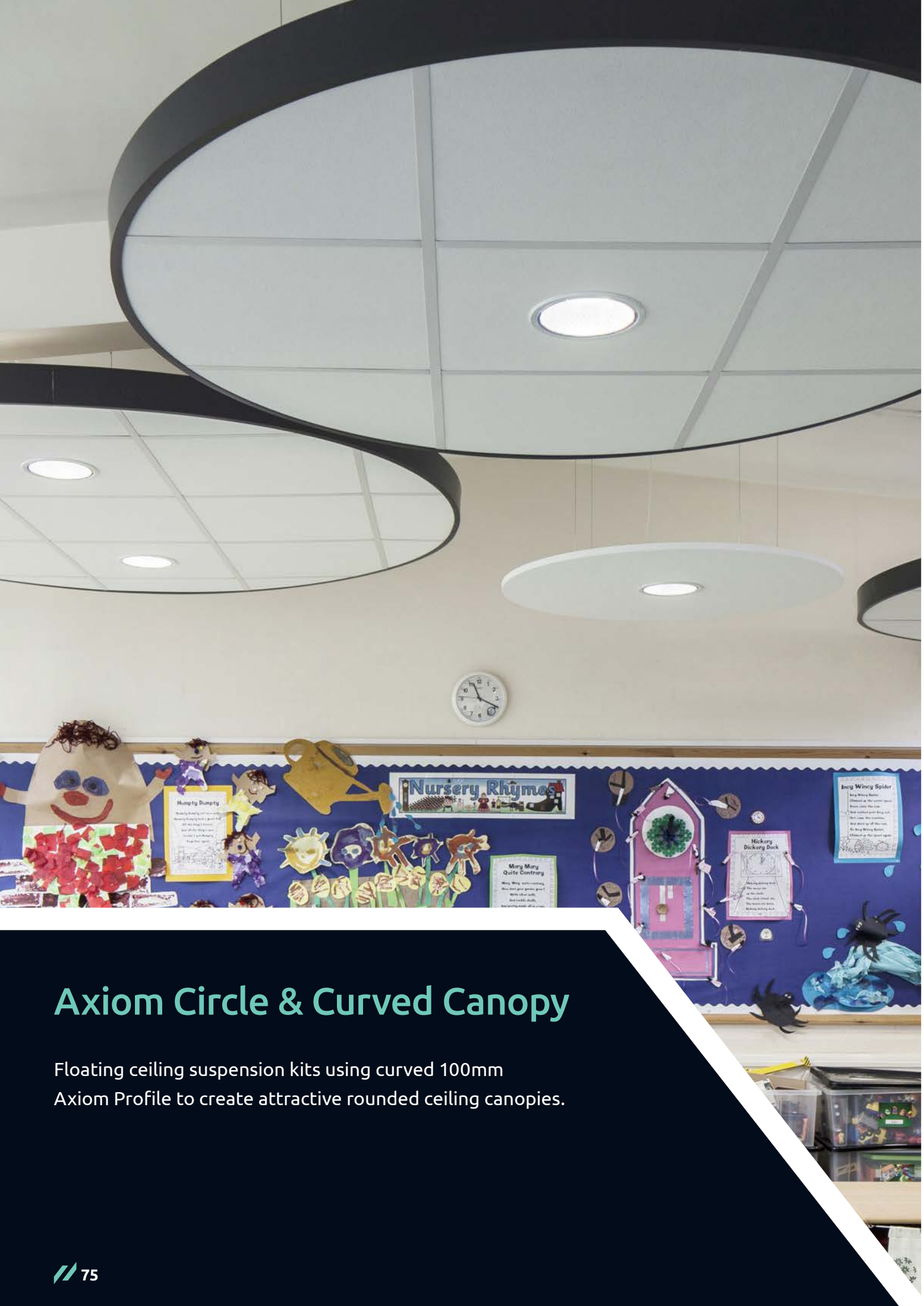

## Axiom Circle & Curved Canopy

Floating ceiling suspension kits using curved 100mm Axiom Profile to create attractive rounded ceiling canopies.

## Key Features

Ceiling tiles are **NOT** included in this kit

- /// Made-to-measure components and accessories all in a single box, ready-to-install for quick and easy installation
- /// Available in 7 standard shapes/modules with Prelude 15 or 24 grid. Custom dimensions available on request
- /// Pre-curved sections for high quality finish – no cutting on site
- /// Ideal for reception areas, meeting areas circulation spaces and retail

Suspension System	Axiom Circle & Curved Canopy – 15mm XL <sup>2</sup>	Axiom Circle & Curved Canopy – 24mm XL <sup>2</sup>
<b>Modules (mm)</b>	Circle Ø1800 ..... CS ACI 33 G15 Circle Ø1800 ..... CS ACI 44 G15 Curved 2400 x 1800 ..... CS ACU 43 G15 Curved 2400 x 2400 ..... CS ACU 44 G15 Curved 3000 x 1800 ..... CS ACU 53 G15 Curved 3000 x 2400 ..... CS ACU 54 G15 Curved 3000 x 3000 ..... CS ACU 55 G15	Circle Ø1800 ..... CS ACI 33 G24 Circle Ø1800 ..... CS ACI 44 G24 Curved 2400 x 1800 ..... CS ACU 43 G24 Curved 2400 x 2400 ..... CS ACU 44 G24 Curved 3000 x 1800 ..... CS ACU 53 G24 Curved 3000 x 2400 ..... CS ACU 54 G24 Curved 3000 x 3000 ..... CS ACU 55 G24
<b>System Width (mm)</b>	15	24
<b>Tile Compatibility</b>	MicroLook 90	Tegular (8mm) / Tegular 90

**Sustainability**



A+



E1  
EN 13964

**Fire Reaction<sup>1</sup>**



EEA Euroclass A2-s1, d0  
EN 13501-1

<sup>1</sup>For the Canopy kit

**Performances & Features**









**30 Year  
System  
Guarantee**

Other performances values will depend upon the infill tile used with the Axiom Circle or Curved Canopy

**Custom Options**



Dimensions



Shapes



Service  
Integration

## Installation Layout

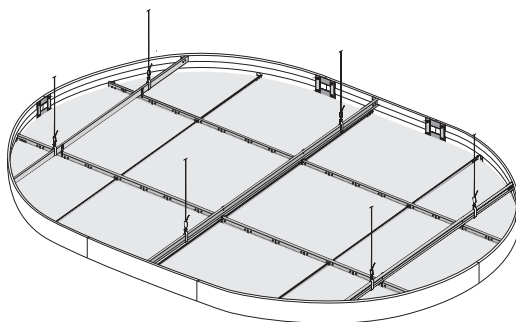
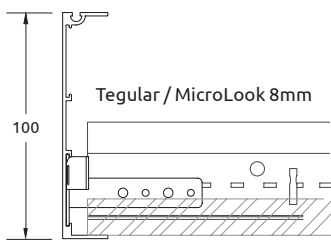

### Axiom Curved Canopies

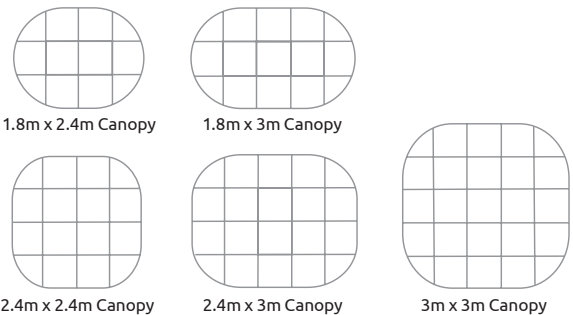

### Axiom Circle Canopies

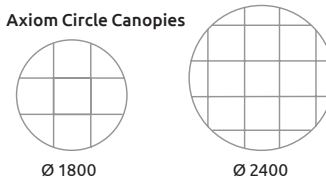











## Axiom L Canopy

Floating ceiling suspension kits using a shorter Axiom Profile frame to create simpler ceiling canopy.

## Key Features

Ceiling tiles are **NOT** included in this kit

- ✓ Made-to-measure components and accessories all in a single box, ready-to-install for quick and easy installation
- ✓ Available in 5 standard modules with Prelude 24 Sixty<sup>2</sup> Main Runner for installation with full size ceiling tiles
- ✓ Ideal for reception areas, meeting areas circulation spaces and retail

<b>Suspension System</b>	<b>Axiom L Canopy – 24mm XL<sup>2</sup></b>			
<b>Modules (mm)</b>	1800 x 1200.....	CS AL 32	G24	
	1800 x 1800.....	CS AL 33	G24	
	2400 x 1200.....	CS AL 42	G24	
	2400 x 1800.....	CS AL 43	G24	
	2400 x 2400.....	CS AL 44	G24	
<b>Suspension System Width (mm)</b>	24			
<b>Tile Compatibility</b>	Board / Tegular			
<b>Sustainability</b>	 A+	 EN 13964 E1		
<b>Fire Reaction<sup>1</sup></b>	 EEA	Euroclass A2-s1, d0 EN 13501-1		<sup>1</sup> For the Canopy kit
<b>Performances &amp; Features</b>				 30 Year System Guarantee
<b>Custom Options</b>	 Dimensions			

## Installation Layout

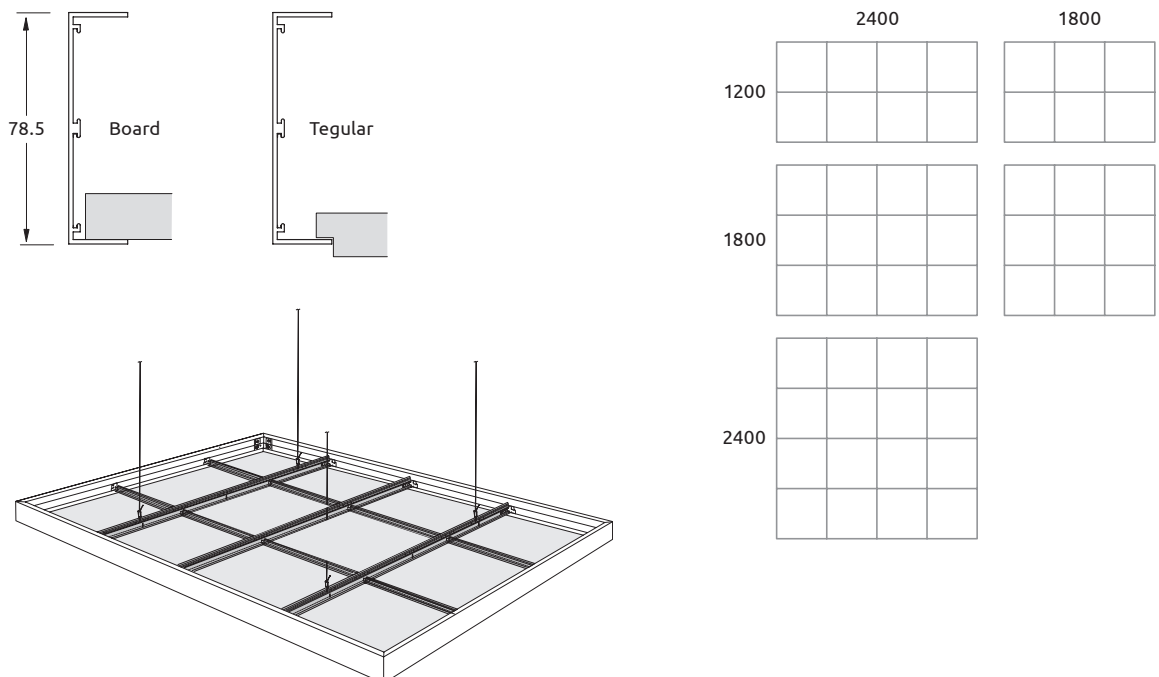



## Baffles

Baffles is a range of high performance acoustical baffles, available in two standard dimensions, with integrated suspension anchor factory fitted for easy alignment and installation.

## Key Features

- ✔ Modern linear appearance
- ✔ Great acoustic performance: Reduce noise levels, increase speech intelligibility and reduce reverberation time in the space
- ✔ Integrated suspension anchor factory fitted for easy alignment and installation
- ✔ Install individually or in groups
- ✔ High light reflectance for energy savings
- ✔ Ideal for schools, offices, leisure centres and transport hubs

<b>Thickness (mm)</b>	40
<b>Modules (mm)</b>	1200 x 400 ..... BAF1200RE 1800 x 400 ..... BAF1800RE
<b>Suspension Systems</b>	Hanging Wire Kit ..... HWKA Prelude 24 Hanging Kit – Black ..... P24HKBZC Prelude 24 Hanging Kit – White ..... P24HKWH Baffles Connector Kit ..... BCKI

## Sustainability



85%



EN 13964 / E1

## Acoustics



EN ISO 354  
& EN ISO 11654

	$\alpha_w$	Class	NRC	Hz $\alpha_p$				
				125	250	500	1000	2000
Baffles row at 300mm centres	0.60(MH)	C	0.65	0.05	0.38	0.55	0.86	0.79

## Fire Reaction



EEA Euroclass A2-s2, d0  
EN 13501-1

## Performances & Features



87%



90% RH



30 Year System Guarantee



1200 x 400: 2.5 kg/pc  
1800 x 400: 4 kg/pc



## Installation Options

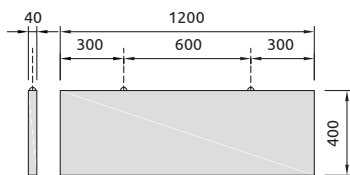

Module 1200 x 400 mm

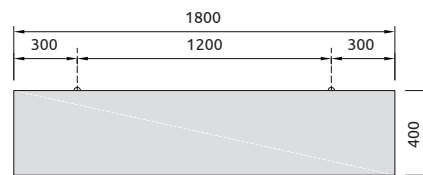

Module 1800 x 400 mm

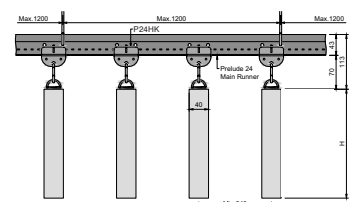





## Canopy

Canopy is a range of floating ceilings providing high levels of sound absorption and available in three shapes – square, rectangle and circle.

## Key Features

- ✔ A cost effective design solution for open areas providing excellent sound absorption and light reflectance
- ✔ To be used in new spaces or renovate an existing area
- ✔ Very easy and quick to install under plasterboard ceilings, existing grid systems or exposed concrete soffits
- ✔ White on all surfaces giving a high quality appearance

<b>Thickness (mm)</b>	40
<b>Shapes &amp; Sizes (mm)</b>	Canopy Square 1200 x 1200..... CAN 1200SQ Canopy Rectangle 1800 x 1200 ..... CAN 1800RE Canopy Rectangle 2400 x 1200 ..... CAN 2400RE Canopy Circle 1200 ..... CAN 1200CI
<b>Suspension Systems</b>	Basic Spiral Anchor Hanging Kit..... BSAHK Spiral anchor for Wall Hanging..... RSAWH

## Sustainability



85%



EN 13964 / E1

## Acoustics

Canopies	Sabines (m <sup>2</sup> ) <sup>1</sup>	1/3 Octave Band Value (α <sub>s</sub> )																	
		100 Hz	125 Hz	160 Hz	200 Hz	250 Hz	315 Hz	400 Hz	500 Hz	630 Hz	800 Hz	1000 Hz	1250 Hz	1600 Hz	2000 Hz	2500 Hz	3150 Hz	4000 Hz	5000 Hz
Square	2.76	0.50	0.70	0.60	0.90	1.20	1.50	1.60	2.10	2.50	3.30	3.20	3.10	3.00	2.90	2.90	2.70	3.00	2.80
Medium Rectangle B	4.07	0.67	1.07	1.07	1.33	1.73	2.13	2.40	2.93	3.87	4.40	4.67	4.40	4.53	4.53	4.53	4.13	4.13	4.40
Large Rectangle	5.22	0.70	1.30	1.30	1.70	2.50	2.60	3.30	4.00	5.10	5.80	5.70	5.90	5.70	5.70	5.70	5.40	5.50	5.40
Circle	2.17	0.39	0.55	0.47	0.71	0.94	1.18	1.26	1.65	1.96	2.59	2.51	2.43	2.36	2.28	2.28	2.12	2.36	2.20

<sup>1</sup>Average 250-4000 Hz

## Fire Reaction



EEA Euroclass A2-s2, d0  
EN 13501-1

## Performances & Features



87%



90% RH



Square: 6.9 kg/pc  
Medium Rectangle B: 11 kg/pc  
Large Rectangle: 13.8 kg/pc  
Circle: 5.4 kg/pc



30 Year System Guarantee

## Custom Options



Colours



Shapes



Dimensions

## Installation Options

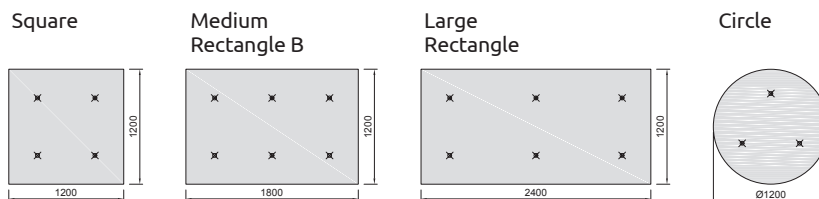

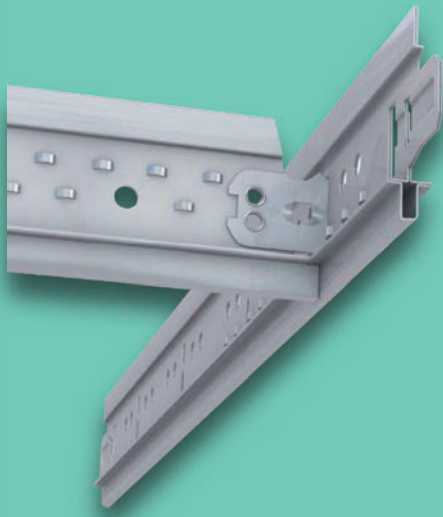

## Suspension system solutions

Zentia suspension systems include a full range of solutions and detailing for all ceiling suspension requirements. A full range of accessories is also available.

- // General solutions
- // Design solutions
- // Specific solutions
- // Primary grid systems
- // Floating suspension solutions
- // Corridor solutions
- // Integrated solutions

## General Solutions

A range of standard exposed grid suspensions systems including Prelude 15, Prelude 24, Prelude 24 Sixty2 for longer spans and Prelude 35.

### Peakform

Most profiles in the Prelude range of grids feature the innovative Peakform design which is taller and engineered to create stronger, more stable suspension systems. The Peakform shape makes Main Runners and Cross Tees quicker and easier to cut.

### Prelude Universal Main Runner

The Prelude Universal Main Runner supports the installation of either TLS or TL hook/butt cut Cross Tees or XL<sup>2</sup> stab/override Cross Tees from one simple inventory of Main Runners.

### XL<sup>2</sup> Cross Tees – “Click” installation

Prelude XL<sup>2</sup> Cross Tees feature an advanced stab system that locates with an audible click, ensuring a solid installation at all times.

### TLS Cross Tees – “Hook” installation

TLS is a highly engineered staked-on hook solution with a patented clip.

### TL Cross Tees – “Hook” installation

Prelude TL Cross Tees in 15mm width feature an advanced integrally formed hook nose.

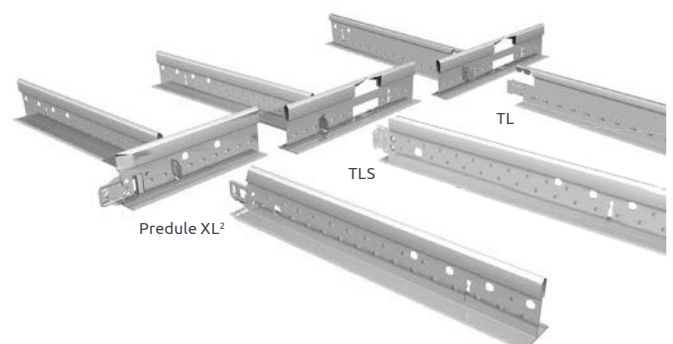

# Design solutions

Zentia's designer grid range features two key products: Silhouette XL<sup>2</sup> & Interlude HRC XL<sup>2</sup>.



## Silhouette XL<sup>2</sup>

Designed to create a crisp, clean look in conjunction with Zentia MicroLook 90, MicroLook BE to provide an enhanced aesthetic. The channel profile finishes flush with the ceiling surface leaving a minimalist 3mm or 6mm reveal.

## Interlude HRC XL<sup>2</sup>

A unique double reveal solution developed to allow flexibility of layout for creative ceiling solutions and give a clean sophisticated appearance with any Zentia MicroLook tile.



## Specific Solutions

- /// Our extensive range of performance grids offers specific solutions for more demanding applications from clean rooms to seismic installations
- /// **Clean Room 24** is a unique co-extrusion of aluminium with a pvc gasket to create a better seal between tile and grid for clean room applications and "non-magnetic" environments
- /// **Prelude 24 Corrosive Resistant** has a special paint finish and is designed for areas requiring enhanced corrosion resistance
- /// **System Z** is a system providing an accessible semi-concealed appearance with ship-lap SL2 planks
- /// **Seismic Rx<sup>®</sup>** is a specific installation method for Prelude 24 grid with XL<sup>2</sup> Cross Tees combined with specialist accessories



## Floating Suspension Solutions

Create an almost limitless range of exciting floating ceilings using our wide range of Axiom Canopy suspension kits including made-to-measure components and accessories all in a single box, ready-to-install for quick and easy installation and pre-fabricated corner sections for high quality corner detailing.

## Solutions for Corridors

Options for corridor solutions include System Z with SL2 planks.

## Integrated Solutions

Axiom Transitions, Profiles and Blind Boxes compliment the traditional range of perimeter angle trims. Create changes in level, perimeter lighting features or transition to a flush plasterboard perimeter.

# Product selector

Edge detail compatibility.

	AXIOM Transitions / Profiles	Silhouette - XL <sup>2</sup>	Interlude HRC - XL <sup>2</sup>	Prelude 15 - TL & TLS	Prelude 24 - XL <sup>2</sup>	Prelude 24 - TLS	Prelude 24 Sixty <sup>2</sup> - XL <sup>2</sup>	Prelude 35 - XL <sup>2</sup>	Clean Room 24	Prelude 24 CR	System Z	Prelude 24 Main Runner
<b>Mineral Lay-In</b>												
Vector	•				•		•					
MicroLook 90	•	•	•	•								
MicroLook	•		•	•								
MicroLook BE	•	•	•	•								
Tegular	•				•	•	•		•	•		
Board	•				•	•	•	•	•	•		
SL2	•										•	

## Standard Colours



GLOBAL WHITE



SILVER GREY RAL 9006



BLACK



WHITE RAL 9010



GALVANISED



BLACK/WHITE

Prelude 24	•	•	•	•		
Prelude 15	•	•	•	•		
Silhouette XL2 6 mm	•			•		•
Interlude HRC - XL <sup>2</sup>	•					
Prelude 35 & Prelude 35 Sixty <sup>2</sup> - XL <sup>2</sup>	•			•	•	
Prelude 24 Sixty <sup>2</sup>	•	•		•	•	
Prelude 24 Corrosive Resistant	•					
Clean Room 24	•					
Axiom System	•				•	

# Prelude 15 TL & XL<sup>2</sup>

Exposed 15mm grid system.

## Key Features

- Peakform  patented design for strength, stability and easier to cut
- Superlock clip: secure Main Runner connection for better alignment and easier to disconnect
- Rotary stitched: strength and extra stability
- Ideal for classrooms, meeting rooms and individual offices

## Physical Data

- Material: galvanised steel
- Surface finish: baked polyester paint
- Colour: Global White / RAL 9010
- Other standard colours available on popular items

## Universal Peakform Main Runner & Superlock Clip (Bulb-to-Bulb Connection)

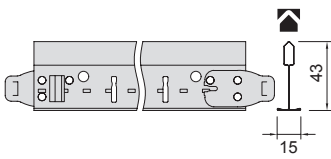

Item No.	Dimensions (mm)				Standard Colours			
	Length	Width	Height	Slot Centres	Global White	White RAL 9010	Silver RAL 9006	Black
 30 40 33 A	3600	15	43	100	•	•	•	•

## XL<sup>2</sup> Peakform Cross Tees (Stab System, Override)

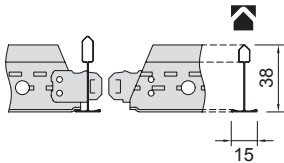

Cross Tees Slotted									
 30 30 33 B	1200	15	38	300	•	•	•	•	•
					<sup>1</sup> Slots at: 300, 550, 600, 650, 900mm <sup>2</sup> Slots at: 150, 500, 750, 1000, 1350mm				

Cross Tees Unslotted									
30 20 33 B	600	15	38	-	•	•	•	•	•

## TL Cross Tees (Hook System, Butt Cut)

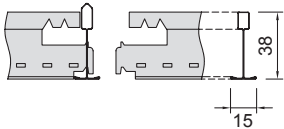

Cross Tees Slotted									
10 30 33 A	1200	15	38	300	•	•	•	•	•

Cross Tees Unslotted									
10 20 33 A	600	15	38	-	•	•	•	•	•

## Sustainability



25



A+



EN 13964  
E1

## Fire Reaction



EEA

Euroclass A1  
EN 13501-1

## Performances & Features



30 Year  
System  
Guarantee



# Prelude 24 TLS

Exposed 24mm grid system.

## Key Features

- Peakform  patented design for strength, stability and easier to cut
- Superlock clip: secure Main Runner connection for better alignment and easier to disconnect
- Unique steel based TLS composite clip for strength, fire performance and better alignment and easier to disconnect
- Rotary stitched: strength and extra stability
- Ideal for classrooms, meeting rooms and individual offices

## Physical Data

- Material: galvanised steel
- Surface finish: baked polyester paint popular items

## Prelude 24 – Universal Peakform Main Runner & Superlock Clip (Bulb-to-Bulb Connection)

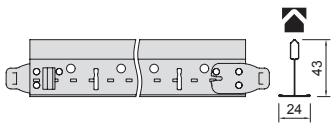

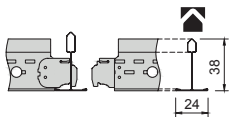

Item No.	Dimensions (mm)				Standard Colours				
	Length	Width	Height	Slot Centres	Global White	White RAL 9010	Silver RAL 9006	Black	Chrome
 31 40 32 A	3600	24	43	100	•	•	•	•	•

## Prelude 24 – TLS Cross Tees (Hook System, Butt Cutt)

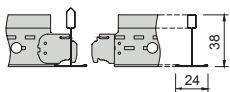

Cross Tees Slotted									
 09 30 31	1200	24	38	300	•	•	•	•	•



Cross Tees Unslotted									
 09 20 31	600	24	38	-	•	•	•	•	•

<sup>1</sup>Slots at 150, 500, 750, 1000, 1350mm

## Sustainability



25



A+



EN 13964  
E1

## Fire Reaction



EEA Euroclass A1  
EN 13501-1

## Performances & Features



30 Year  
System  
Guarantee



# Prelude 24 XL<sup>2</sup>

Exposed 24mm grid system.

## Key Features

- Peakform  patented design for strength, stability and easier to cut
- Superlock clip: secure Main Runner connection for better alignment and easier to disconnect
- Rotary stitched: strength and extra stability
- Ideal for classrooms, meeting rooms and individual offices

## Physical Data

- Material: galvanised steel
- Surface finish: baked polyester paint
- Colour: all products in Global White / RAL 9010

## Universal Peakform Main Runner & Superlock Clip (Bulb-to-Bulb Connection)

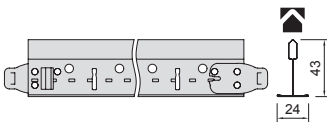

Item No.	Dimensions (mm)				Standard Colours				
	Length	Width	Height	Slot Centres	Global White	White RAL 9010	Silver RAL 9006	Black	Chrome
31 40 32 A	3600	24	43	100	•	•	•	•	•

## XL<sup>2</sup> Peakform Cross Tees (Stab System, Override)

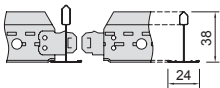

### Cross Tees Slotted

31 30 51 B	1200	24	38	300	•	•	•	•
------------	------	----	----	-----	---	---	---	---

<sup>1</sup>Slots at: 150, 500, 750, 1000, 1350mm

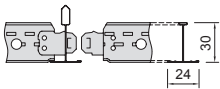

### Cross Tees Unslotted

31 20 21 A	600	24	30	-	•	•	•	•
------------	-----	----	----	---	---	---	---	---

## Sustainability



25



A+



EN 13964  
E1

## Fire Reaction



EEA Euroclass A1  
EN 13501-1

## Performances & Features





# Prelude 24 Sixty<sup>2</sup>

Taller exposed 24mm grid system for longer spanning capability.

## Key Features

- Peakform  patented design for longer spans, stability and easier to cut
- Superlock clip: secure Main Runner connection for better alignment and easier to disconnect
- Compatible with Prelude 24 TLS and XL2 Cross Tees
- Ideal for circulation areas and buildings with limited suspension points

## Physical Data

- Material: galvanised steel
- Surface finish: baked polyester paint
- Colour: all products in Global White / RAL 9010

## Prelude 24 Sixty<sup>2</sup> – Universal Double Peakform Main Runner with Superlock Clip (Bulb-to-Bulb)

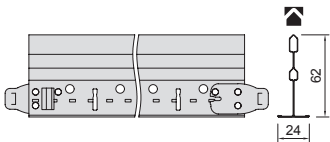

Item No.	Dimensions (mm)				Standard Colours			
	Length	Width	Height	Slot Centres	Global White	White RAL 9010	Silver RAL 9006	Black
40 40 93 G	3600	24	62	100	•			

## Prelude 24 – XL<sup>2</sup> Cross Tees (Stab System, Override)

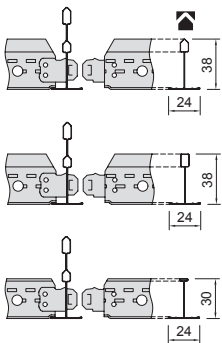

### Cross Tees Slotted

31 30 51 B	1200	24	38	300	•	•	•	•
------------	------	----	----	-----	---	---	---	---

\*Slots at: 150, 500, 750, 1000, 1350mm

### Cross Tees Unslotted

31 20 21 A	600	24	30	-	•	•	•	•
------------	-----	----	----	---	---	---	---	---

## Sustainability



25



A+



EN 13964  
E1

## Fire Reaction



EEA

Euroclass A1  
EN 13501-1

## Performances & Features



30 Year  
System  
Guarantee



# System Z Prelude 24 / Corridor

Components for concealed / semi-concealed plank systems.

## Key Features

- ✔ Z-Bar or Prelude 24 Butt Cut for a monolithic in corridor installations
- ✔ Installed with Prelude 24 for semi-concealed appearance in room installations
- ✔ Accessible system with SL2 planks
- ✔ Ideal for retail outlets, industrial manufacturing and circulation areas

## Physical Data

- ✔ Material: galvanised steel
- ✔ Surface finish: galvanised / baked polyester paint
- ✔ Colour: n/a Z-Bar / Global White (Prelude 24 Butt Cut)

## Semi-Concealed

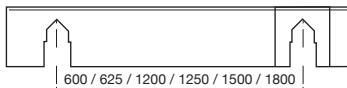
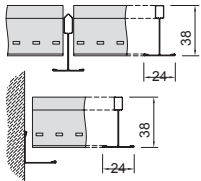
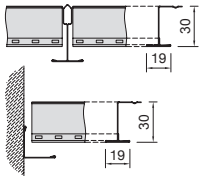

Item No.	Description	Dimensions (mm)			Standard Colours	
		Length	Width	Height	Global White	Galvanised
CZ 41 494 J	Z-Bar 30.5mm	1500	19	30	•	•
CZ 41 794 J	Z-Bar 30.5mm	1800	19	30	•	•
CZ 41 795 J	Z-Bar 66.5mm	2500	19	66.5	•	•
CB 31 36 32	Prelude 24 Butt Cut	1500	24	38	•	•
CB 31 34 32	Prelude 24 Butt Cut	1800	24	38	•	•
C 180 L 600	Space Bar	600			•	•
C 180 L 1200	Space Bar	1200			•	•
C 180 L 1500	Space Bar	1500			•	•
C 180 L 1800	Space Bar	1800			•	•

## Sustainability



25



A+



EN 13964  
E1

## Fire Reaction



EEA Euroclass A1  
EN 13501-1

## Performances & Features



# Silhouette XL<sup>2</sup>

Exposed 15mm grid system with channel feature and pre-mitred intersections.

## Key Features

- Peakform  patented design for strength, stability and easier to cut
- 6mm reveal for a more monolithic appearance with MicroLook 90 and MicroLook BE mineral tiles
- Rotary stitched: strength and extra stability
- Ideal for reception areas, open plan office and individual offices

## Physical Data

- Material: galvanised steel
- Surface finish: baked polyester paint
- Colours: all products in Global White, Black, Global White with black reveal and RAL 9010

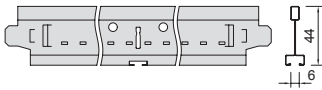

## Silhouette 6mm – Main Runner (By-Pass Connection)

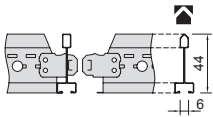

Item No.	Dimensions (mm)				Standard Colours		
	Length	Width	Height	Slot Centres	Global White	White RAL 9010	Global White with black reveal
with 6mm reveal							
87 40 82 G	3600	15	44	600	•		•

## Silhouette 6mm – XL<sup>2</sup> Peakform Cross Tees (Stab Systems)



with 6mm reveal							
 87 30 82 G	1200	15	44	600	•		•
 87 20 82 G	600	15	44	-			•

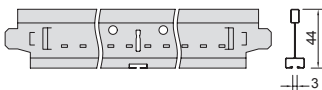

## Silhouette 3mm – Main Runner (By-Pass Connection)

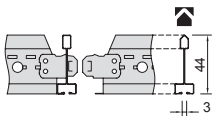

with 3mm reveal							
81 40 42 WRG	3600	15	44	600		•	

## Silhouette 3mm – XL<sup>2</sup> Peakform Cross Tees (Stab System)



with 3mm reveal							
 81 30 42 WRG	1200	15	44	600		•	
 81 20 42 WRG	600	15	44	-		•	

## Sustainability



25



A+



EN 13964  
E1

## Fire Reaction



EEA

Euroclass A1  
EN 13501-1

## Performances & Features



30 Year  
System  
Guarantee



# Interlude HRC XL<sup>2</sup>

Exposed 15mm grid system with double reveal feature.

## Key Features

- Unmitred intersections for flexibility of Cross Tee positioning to create staggered layouts
- Double reveal feature perfect for installation with MicroLook 90 mineral tiles
- Rotary stitched: strength and extra stability
- Ideal for reception areas, open plan offices and individual offices

## Physical Data

- Material: galvanised steel
- Surface finish: baked polyester paint
- Colour: Global White

## Interlude HRC – Main Runner (By-Pass Connection)

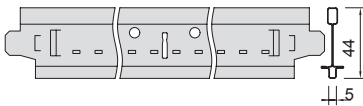

Item No.	Dimensions (mm)				Standard Colours
	Length	Width	Height	Slot Centres	Global White
61 40 42 H	3600	15	44	600	•

## Interlude HRC – XL<sup>2</sup> Cross Tees (Stab System)

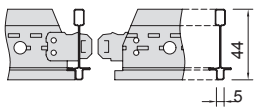

### Cross Tees Slotted

61 30 42 G	1200	15	44	600	•
------------	------	----	----	-----	---

### Cross Tees Unslotted

61 20 42 G	600	15	44	-	•
------------	-----	----	----	---	---

## Sustainability



63



A+



EN 13964  
E1

## Fire Reaction



EEA

Euroclass A1  
EN 13501-1

## Performances & Features



30 Year  
System  
Guarantee



# Prelude 24 Corrosive Resistant TL+

Exposed 24mm grid system for higher humidity environments.

## Key Features

- Special paint finish and coated Cross Tee clips for enhanced corrosion resistance
- 700 hours salt spray test (EN ISO 9227)
- Durability Class C (EN 13964)
- Ideal for high humidity areas

## Physical Data

- Material: galvanised steel with additional protective treatment
- Surface finish: baked polyester paint
- Colour: Global White,

## Prelude 24 Corrosive Resistant – Universal Peakform Main Runner & Superlock Clip (Build-to-Bulb Connection)

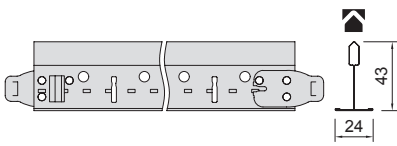

Item No.	Dimensions (mm)				Standard Colours
	Length	Width	Height	Slot Centres	
28 40 42	3600	24	43	100	Global White

## Prelude 24 Corrosive Resistant – TL+ Cross Tees (Hook System, Butt Cutt)

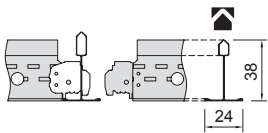

15 30 32	1200	24	38	300	Global White
15 20 32	600	24	38	-	Global White

## Perimeter Solution

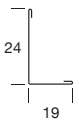

Item No.	Description	Dimensions (mm)		Standard Colours
		Length	Height	
T 1924 LB	Corrosive resistant perimeter angle	3050	24	Global White

## Accessories

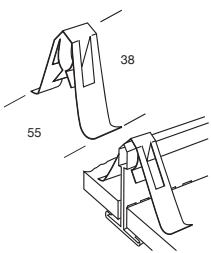

**A CR7890**  
Universal retaining clip

## Sustainability



25



A+



EN 13964  
E1

## Fire Reaction



EEA Euroclass A1  
EN 13501-1

## Performances & Features



**30 Year**  
System  
Guarantee

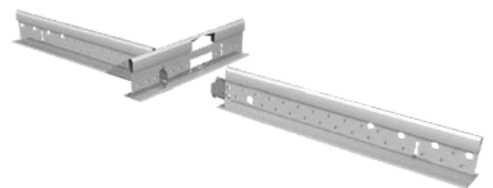

# Clean Room 24 XL<sup>2</sup>

Exposed 24mm co-extruded grid system for clean rooms.

## Key Features

- Aluminium construction: non-magnetic system with high corrosion resistance
- Co-extruded gasket: better seal between tile and grid
- Class 4 performance as per ISO standard 14644-1
- Durability Class B (EN 13964)
- Ideal for healthcare and hi-tech manufacturing

## Physical Data

- Material: co-extruded aluminium with gasket
- Surface finish: extruded PVC
- Colour: Global White

## Clean Room 24 – Main Runner (Bulb-to-Bulb Connection)

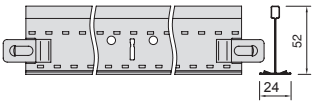

Item No.	Dimensions (mm)				Standard Colours
	Length	Width	Height	Slot Centres	Global White
EA 794044 C	3600	24	52	300	•

## Clean Room 24 – Cross Tees + Perimeter Trim (Stab System, Butt Cut)

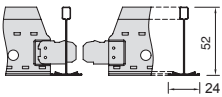

EA 793044 C	1200	24	52	300	•
EA 792044 C	600	24	52	300	•

## Perimeter Solution



EA 7812 C	3660	22	22	-	•
-----------	------	----	----	---	---

## Accessories – Corrosion Resistance 700 Hours Salt Spray Test

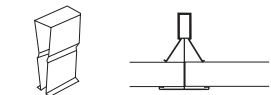

**CHDC**  
Hold down clip suitable for non-magnetic areas

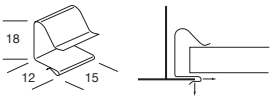

**A 426 G**  
Board access clip

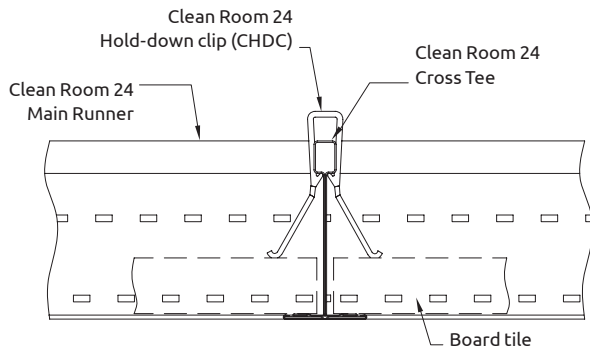

## Sustainability



25



A+



EN 13964  
E1

## Fire Reaction



EEA Euroclass A2-s1,d0  
EN 13501-1

## Performances & Features



# Seismic RX®

Exposed 24mm grid system with specialist installation accessories and detailing.

## Key Features

- ✔ Independently tested system to withstand the forces from significant seismic activity or other severe events
- ✔ Standard grid sections: Prelude 24 Peakform Main Runner and Prelude 24 XL2 Cross Tees
- ✔ Special accessories: quicker, more cost effective seismic installations
- ✔ Solutions for moderate hazard and high/very high hazard areas

- ✔ Ideal for seismic areas, nuclear, military and high risk areas

## Physical Data

- ✔ Material: galvanised steel
- ✔ Surface finish: baked polyester paint
- ✔ Colour: Global White

## Prelude 24 – Universal Peakform Main Runners and Superlock Clip (Bulb-to-Bulb Connection)

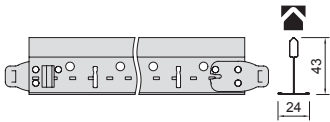

Item No.	Dimensions (mm)				Standard Colours					
	Length	Width	Height	Slot Centres	Global White	White RAL 9010	Silver RAL 9006	Black	Brass	Chrome
31 40 32 A	3600	24	43	100	•	•	•	•	•	•

## Prelude 24 XL<sup>2</sup> – Cross Tees (Stab System, Override)

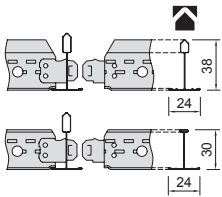

### Cross Tees Slotted

31 31 51 B	1200	24	38	300	•	•	•	•	•	•
------------	------	----	----	-----	---	---	---	---	---	---

### Cross Tees Unslotted

31 20 21 A	600	24	30	-	•	•	•	•	•	•
------------	-----	----	----	---	---	---	---	---	---	---

## Perimeter Angle and Accessories

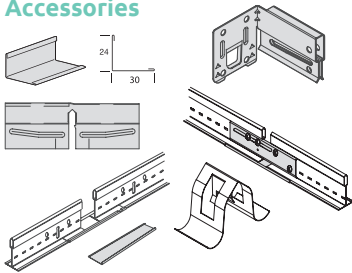

Item No.	Description	Dimensions (mm) Height
T 3024 HA	Perimeter angle, painted (Global White)	3000
BERC2	Main Runner end retaining clip	50
SJCG	Seismic joint clip XL <sup>2</sup> Cross Tee (24mm)	-
SJMR15	Seismic joint clip Peakform Main Runner (24mm)	-
ES 4	Expansion sleeve (24mm)	100
442 A	Vector Seismic Clip	-

## Sustainability



25



A+



EN 13964 E1

## Fire Reaction



EEA

Euroclass A1  
EN 13501-1

## Performances & Features



30 Year  
System  
Guarantee

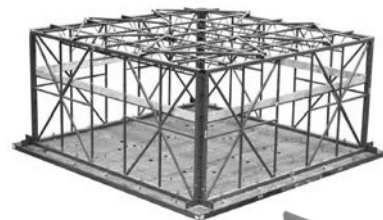

# Prelude 35 XL<sup>2</sup>

Exposed 35mm grid system.

## Key Features

- Peakform  patented design for strength / longer spans, stability and easier to cut
- Superlock clip: secure Main Runner connection for better alignment and easier to disconnect
- Double bent tee bar hanger for stability / improved loadbearing performance in corridors
- Rotary stitched: strength and extra stability

- Ideal for corridors, industrial manufacturing and circulation areas

## Physical Data

- Material: galvanised steel
- Surface finish: baked polyester paint
- Colour: Global White, Black, galvanised

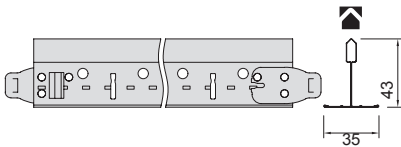

## Universal Peakform Main Runner & Superlock Clip (Bulb-to-Bulb Connection)

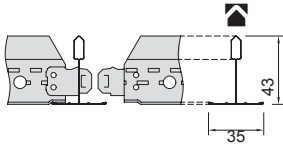

Item No.	Dimensions (mm)				Standard Colours		
	Length	Width	Height	Slot Centres	Global White	Black	Galvanised
 24 40 42	3600	35	43	100	•	•	•

## Prelude 35 XL<sup>2</sup> – Peakform Cross Tees (Stab System, Override)



 24 36 42	1500	35	43	-	•	•	•
 24 30 42	1200	35	43	600	•	•	•
 24 20 42	600	35	43	-	•	•	•

## Accessories

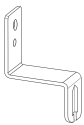

Item No.	Description	Dimensions (mm)	
		Length	Height
 A WDN 23 G	Double bent tee bar hanger	57	36

## Sustainability



25



A+



EN 13964  
E1

## Fire Reaction



EEA Euroclass A1  
EN 13501-1

## Performances & Features



30 Year  
System  
Guarantee





## Perimeter detailing

# Perimeter Trims

Standard perimeter trims for classic perimeter solutions with mineral ceilings.

## Key Features

- Comprehensive range including angle trims, shadowlines trims, channels and F-upstand trims
- All ceilings – perimeters

## Physical Data

- Material: steel
- Surface finish: baked polyester paint
- Colour: Global White
- Other standard colours available on popular items

## Perimeter Detailing

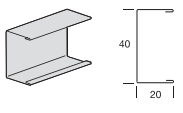
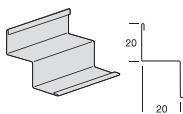
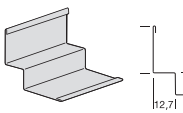
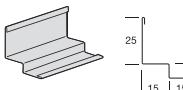
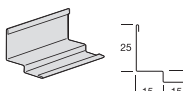
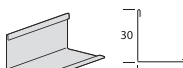
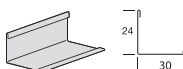
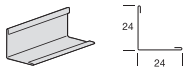
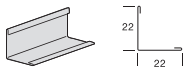
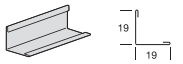
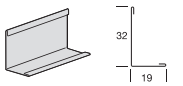
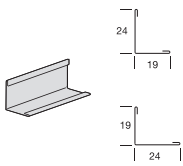

Item No.	Description	Dimensions (mm)		Standard colours				
		Length	Depth	Global White	White RAL 9010	Silver RAL 9006	Black	Galvanised
T 1924 HD	Perimeter angle, painted	3000	0.54	•				
T 1924 CA	Perimeter angle, capped	3050	0.60					
T 1924 LB	Perimeter angle, corrosive resistant	3050	0.55	•				
T 2419 H	Perimeter angle, painted	3000	0.45		•	•	•	
T 1932 HA	Perimeter angle, painted	3000	0.45	•				
T 1919 HC	Perimeter angle, painted	3000	0.45	•				
T 2222 HA	Perimeter angle	3000	0.45	•				
T 2401 HA	Perimeter angle, painted heavy duty	3050	0.70	•				
T 2424 HD	Perimeter angle, painted	3050	0.45	•				
T 3024 HA	Perimeter angle, painted	3000	0.45	•				
T 3030 H	Perimeter angle, painted	3000	0.54	•			•	•
T 1506 H	Shadowline, painted	3050	0.45	•				
T 1508 HB	Shadowline, painted	3050	0.45	•	•	•	•	
7875 G	Shadowline, painted, for Ultima+ Vector, Dune Vector	3050	0.45	•				
T 2020 HH	Shadowline, painted	3000	0.65	•				
T 2040 HB	C channel, painted	3050	0.45	•	•			

# Perimeter Trims

## Perimeter Detailing

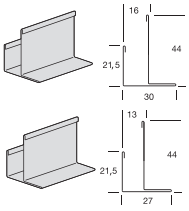

Item No.	Description	Dimensions (mm)		Standard colours
		Length	Thickness	Global White
7856 H	F Upstand trim, painted, for 16 mm thick panels	3050	0.45	•
7852 H	F Upstand trim, painted, for 13 mm thick panels	3050	0.45	•

## Flexible Perimeter Trims

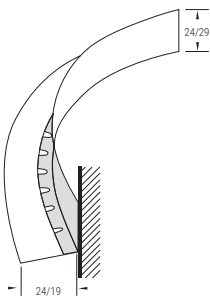

Item No.	Dimensions (mm)		Standard colours
	Length	Thickness	Global White
FT 2424	3050	0.45	•
FT 1929	3050	0.45	•

## Accessories

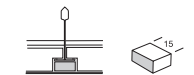
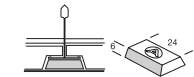
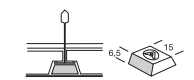
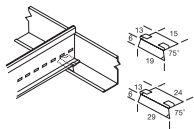
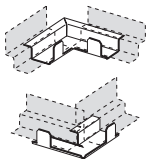
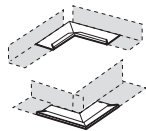

Item No.	Description	Dimensions (mm)	
		Length	
A 328 G	Inside corner 19mm (Global White)	58	
A 329 G	Outside corner 19mm (Global White)	65.5	
A 330 G	Inside corner 24mm (Global White)	58	
A 331 G	Outside corner 24mm (Global White)	65.5	
A 332 G	Inside corner for shadowline T 1508 HB (Global White)	72	
A 333 G	Outside corner for shadowline T 1508 HB (Global White)	57.2	
A 0415 G	MicroLook border clip	19	
A 0324 G	Tegular border clip	29	
A 156 G	Perimeter fill-in clip for 15 mm grid – MicroLook (75° angled)	-	
A 246 G	Perimeter fill-in clip for 24 mm grid – Tegular (75° angled)	-	
A 157	Perimeter fill-in clip for 15 mm grid – MicroLook 90 (90° angled)	15	

# Accessories

## Suspension & Accessories

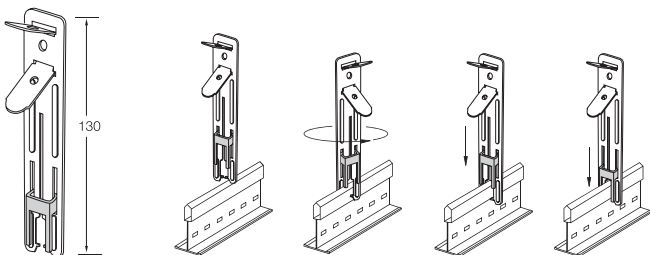
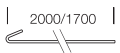
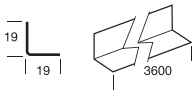
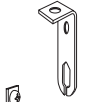
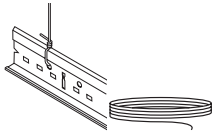

Item No.	Description	Dimensions (mm)
		Length
A W950 G	Suspension wire dia, 2mm	ca, 200 metres
▲ A WDN20 H	Bent T bar hanger for threaded rod	57
▲ A WDN21 H	T bar hanger	-
▲ A WDN23 G	Double bent T bar hanger with 2 sizes of diameter hole	57
A 12020 G	Quick hanger – eye (1 hook + 1 eye)	215-380
A 12040 G	Quick hanger – eye (1 hook + 1 eye)	315-580
A 12070 G	Quick hanger – eye (1 hook + 1 eye)	415-780
A 12090 G	Quick hanger – eye (1 hook + 1 eye)	515-980
A 10204 H	Upper part of Nonius 500mm length	500
A 10229 G	Pin to connect bottom & upper part of Nonius	60
▲ A10230 G	Bottom part Nonius hanger	190
A 952 G	Suspension angle	3600
▲ A 1052 G	Bent residential strap hanger	73
A 826 G	2m hanger with hook	2000
A 827 G	1.7m hanger with hook	1700
A 12 H	Butterfly	55
▲ A 829 H	Suspension hanger for T bae	130

# Perimeter Trims

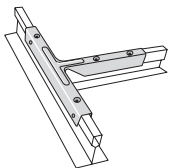
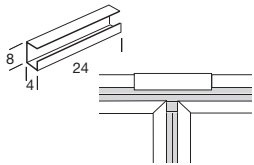
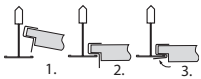
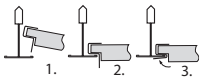
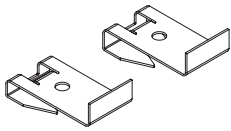
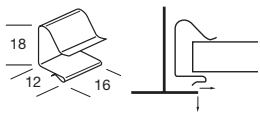
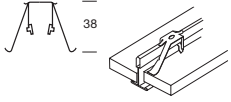
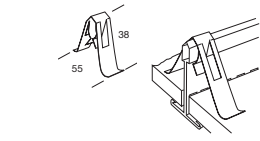

## Suspension & Hold Down Clips



Item No.	Description	Dimensions (mm)	
		Length	
▲ A 7890 G	Universal hold down clip	-	
▲ A 819 G	Locking hold down clip, 6-30mm tiles (Peakform & Square bulb)	64	
▲ A 7902	Hold down clip for 18-25mm soft fibre panels	40	
A 425 G	Board Access clip for standard 24mm T-bar	-	
A 426 G	Board Access clip for Clean Room 24 T-bar (Global White)	-	
440 B	Ultima+ Vector border clip	-	
441 A	Optima Vector border clip	-	
442 A	Vector Seismic clip	-	
A 7930 G	Last tile clip Tegular (Global White)	40	
A 7931 G	Last tile clip MicroLook (Global White)	40	
MCC4 G	Mitre closure clip for 6mm Silhouette (Global White)	-	
▲ A 131 G	T bar saddle clip (Peakform & Square bulb)	98	

# Accessories

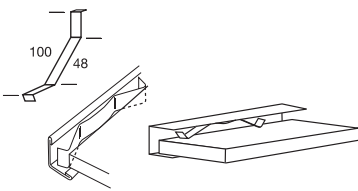
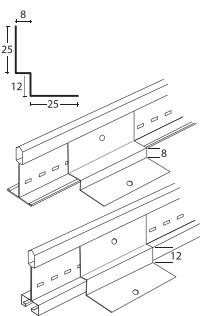
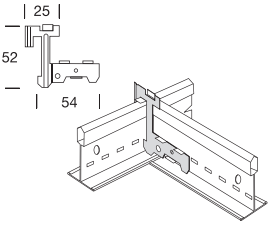
## Additional Accessories

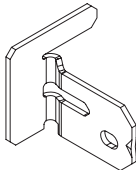
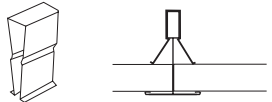
Item No.	Description	Dimensions (mm)	
		Length	
	A 1796 G	Border wedge	-
	UPC AG	Universal partition clip	-
	 C 1430	Variable placement hook end detail to suit on site	63.5
	A SP H	Grid touch-up paint	-
	STAC	Single tee adapter clip	-
	CHDC	PVC hold down clip for Clean Room grids	-

# Axiom Profiles

Extruded aluminium sections for perimeter detailing, changes of level and lighting features.

## Key Features

- ✔ Available in 5 different heights with Axiom corner posts and universal accessories for secure and easy installation
- ✔ Compatible with Zentia exposed ceilings grid systems including Silhouette and Interlude HRC designer grids
- ✔ Plasterboard trims for seamless integration with plasterboard ceilings

- ✔ Factory finished, no on-site decoration required – save time on plastering, sanding and painting
- ✔ Ideal for perimeters / changes in level / lighting features

## Physical Data

- ✔ Material: aluminium
- ✔ Surface finish: polyester powder paint
- ✔ Colour: all products in Global White / RAL 9010

## Product Range

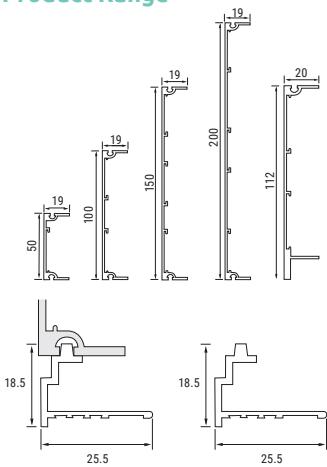

Item No.	Description	Dimensions (mm)		Standard Colours	
		Length	Height	Global White	White RAL 9010
52 42 06 G	Axiom Profiles 50mm	3000	50	•	•
54 42 06 G	Axiom Profiles 100mm	3000	100	•	•
56 42 06 G	Axiom Profiles 150mm	3000	150	•	•
58 42 06 G	Axiom Profiles 200mm	3000	200	•	•
55 14 11 G	Axiom Vector Profiles 112mm	3000	112	•	•
T 3213 H	Axiom Profiles plasterboard trim	3000	18.5	•	•

## Accessories

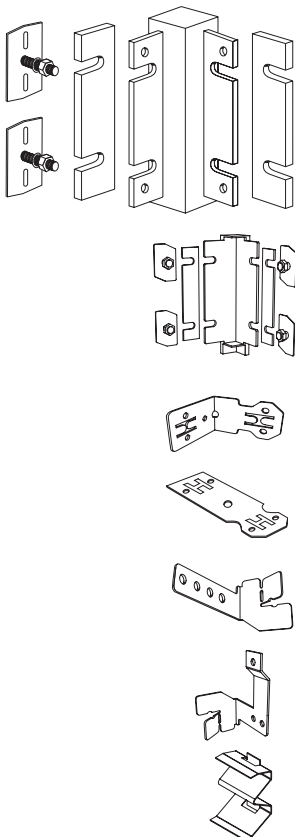

Item No.	Description	Standard Colours	
		Global White	White RAL 9010
A 334 G	Axiom Profiles corner post 50mm	•	•
A 335 G	Axiom Profiles corner post 100mm	•	•
A 336 G	Axiom Profiles corner post 150mm	•	•
A 337 G	Axiom Profiles corner post 200mm	•	•
A 345 G	Axiom Vector corner post 112mm	•	
A 340 H	Axiom Universal corner clip		
A 338 H	Axiom Universal splice plate		
A 339 J	Axiom Universal T bar connector clip		
A 344 H	Axiom Universal hanging clip		
A 7935	Axiom Universal hold down clip for cut metal tiles		

**System Drawing**

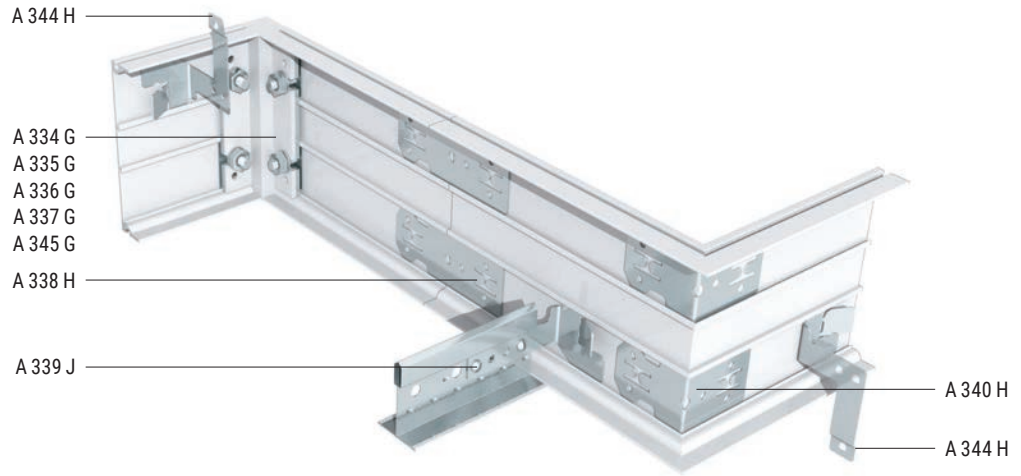

**Concealed Lighting Detail**

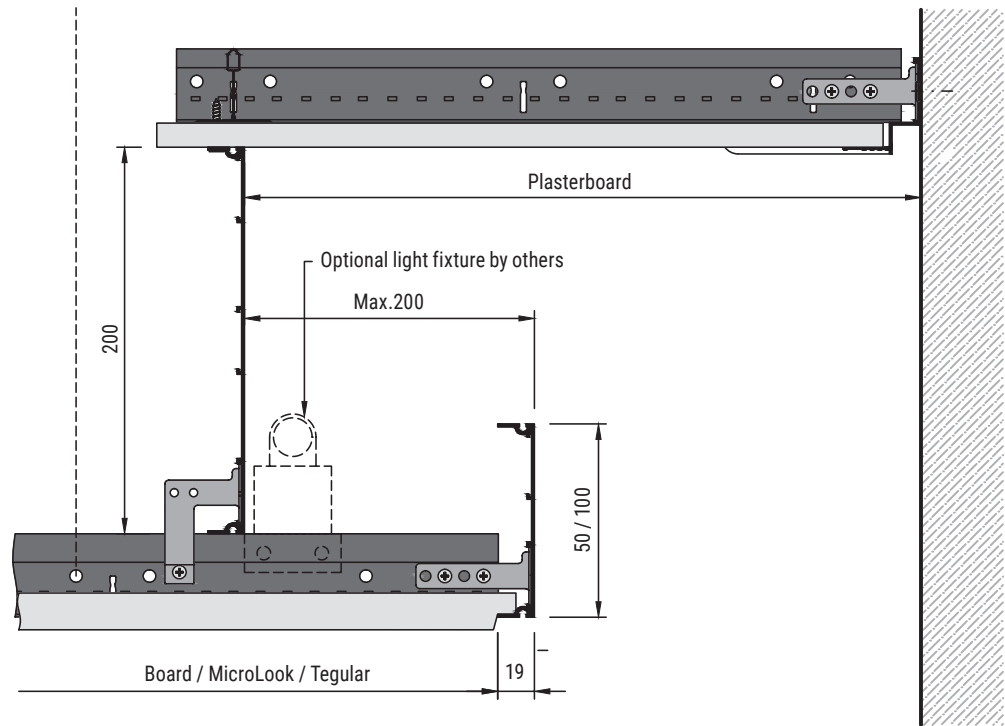

**Sustainability**



**Fire Reaction**



**Performances & Features**



**Custom Options**





# Axiom Transitions

Extruded aluminium sections to provide a seamless transition between plasterboard margins and suspended ceilings.

## Key Features

- // 12 sections designed for compatibility with different edge details using Axiom universal accessories for secure and easy installation
- // Compatible with Zentia exposed ceiling grid systems including Silhouette and Interlude HRC designer grids
- // Plasterboard jointing flange for seamless integration with plasterboard ceilings

- // Application Areas: perimeters

## Physical Data

- // Material: aluminium
- // Surface finish: polyester powder painted
- // Color: Global White / RAL 9010
- // Other colours available upon request

## Product Range

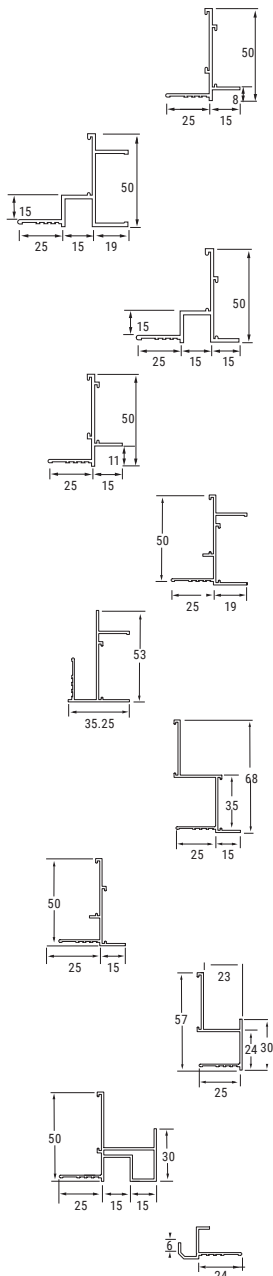

Item No.	Description	Dimensions (mm)		Standard Colours	
		Length	Height	Global White	White RAL 9010
T 3208 G	Axiom Transitions for Tegular/MicroLook	3000	50	•	•
T 3219 G	Axiom Transitions shadowline channel	3000	50	•	•
T 3215 G	Axiom Transitions shadowline angle	3000	50	•	•
T 3210 G	Axiom Transitions for Vector tiles	3000	50	•	•
T 3228	Axiom Transitions channel	3000	50	•	•
T 3230	Axiom Transitions upstand channel 13mm board	3000	53	•	•
T 3273	Axiom Transitions angle with offset 25mm	3000	68	•	•
T 3271	Axiom Transitions angle	3000	51	•	•
T 3272	Axiom Transitions Channel for hook on metal tiles	3000	57	•	•
T 3276	Axiom Transitions Shadowline for hook on metal tiles	3000	51	•	•
T 3277	Axiom Transitions for Clip in metal tiles	3000	18	•	•

## System Drawing

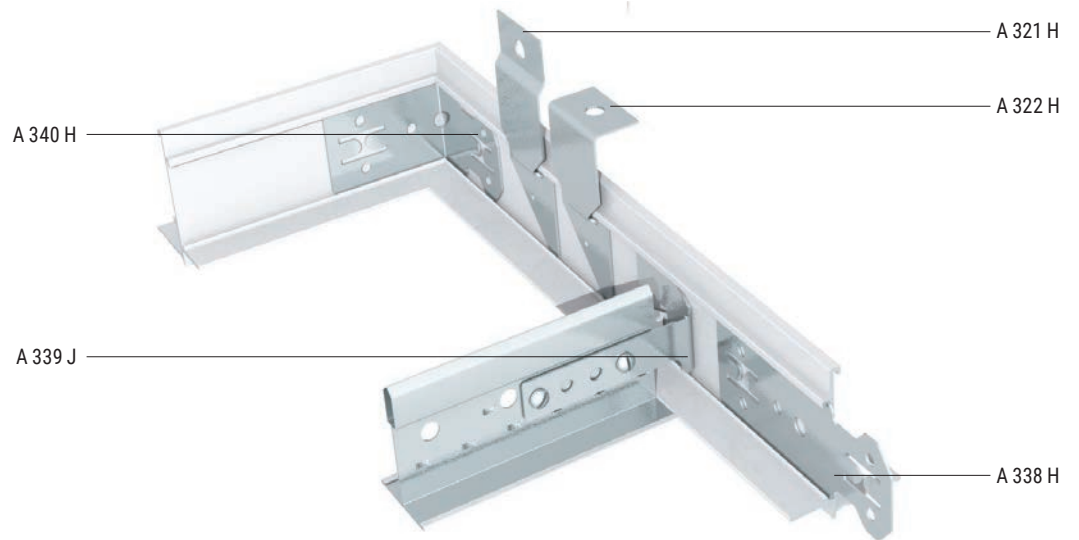

## Cross Section

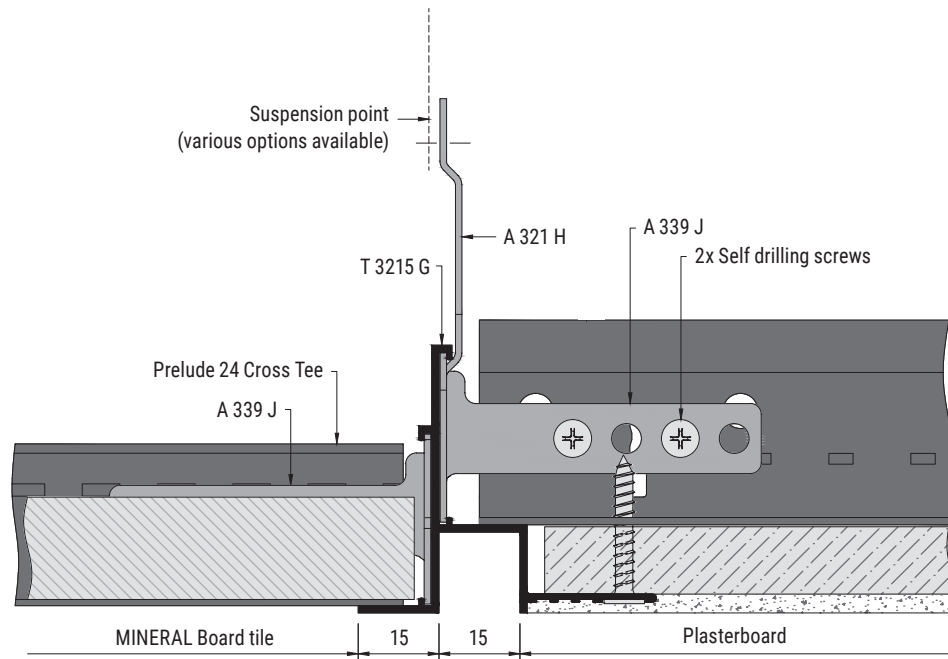

## Sustainability



A+



EN 13964  
E1

## Fire Reaction



EEA Euroclass A2-s1, d0  
EN 13501-1

## Other Performances & Features



30 Year  
System  
Guarantee

## Custom Options



Dimensiones

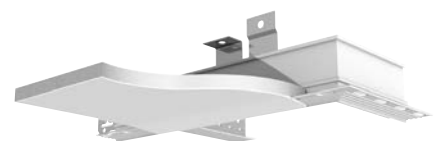

# Axiom Blind Boxes

Extruded aluminium profiles for detailing perimeter blind boxes or concealed lighting features.

## Key Features

- // Pre-engineered profiles using Axiom universal accessories for a secure and easy installation
- // Provide a sharp finish to integrate with suspended ceiling tiles or plasterboard ceilings
- // Factory finished, no on-site decoration required – save time on plastering, sanding and painting
- // All ceilings – perimeters / lighting features

## Physical Data

- // Material: aluminium
- // Surface finish: polyester powder paint
- // Colour: Global White / RAL 9010

## Product Range

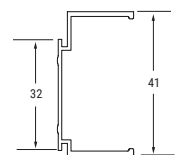
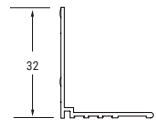
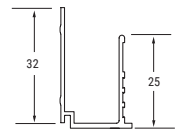
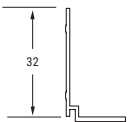
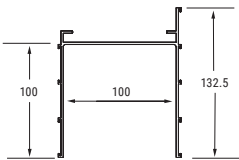

Item No.	Description	Dimensions (mm)		Standard Colours	
		Length	Height	Global White	White RAL 9010
T 3250	Axiom Blind Box 100mm	3000	132.5	•	•
T 3251	Axiom Blind Box Perimeter angle	3000	32	•	•
T 3252	Axiom Blind Box Transition upstand 13mm Board	3000	32	•	•
T 3253	Axiom Blind Box Transition angle	3000	32	•	•
T 3254	Axiom Blind Box Perimeter channel	3000	41	•	•

## Accessories

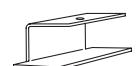
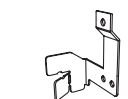
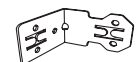

Item No.	Description	Dimensions (mm)	
		Length	Height
A 334 G	Axiom Universal corner clip	-	-
A 335 G	Axiom Universal splice plate	-	-
A 336 G	Axiom Universal hanging clip	-	-
A 3255	Hanger for Axiom Blind Box	-	25

**Cross Sections**

**Cross Section  
Cut Metal Tile**

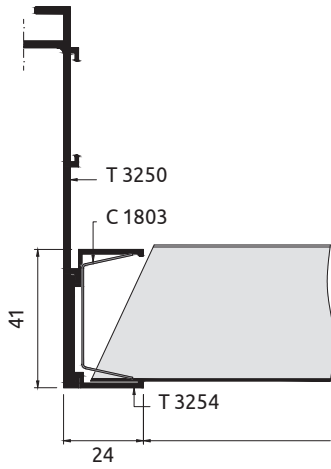

**Cross Section  
MicroLook / Tegular**

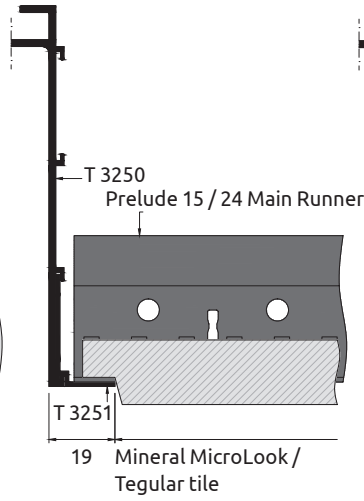

**Cross Section  
Plasterboard Horizontal**

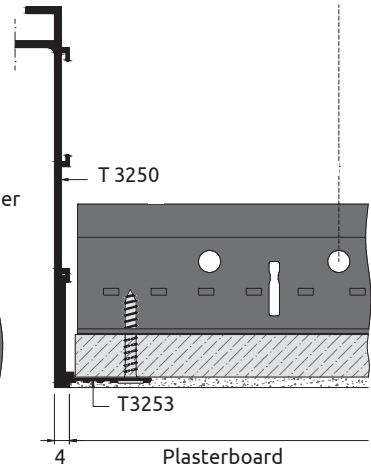

**Cross Section  
Plasterboard Vertical**

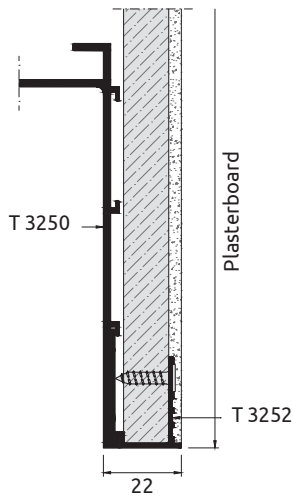

**Axiom Blind Box  
to Wall**

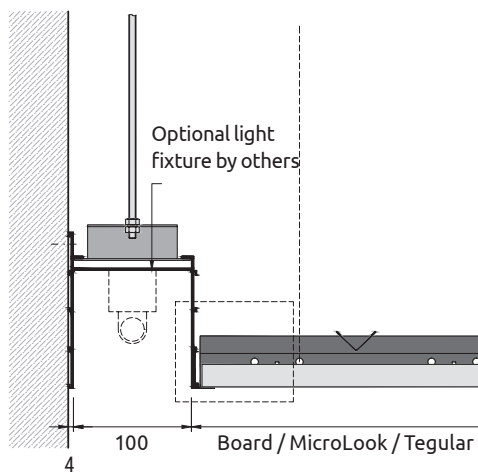

**Sustainability**



A+



EN 13964  
E1

**Fire Reaction**



EEA Euroclass A2-s1, d0  
EN 13501-1

**Performances  
& Features**



**Custom Options**



Dimensions

# Axiom Perimeter Angles / Channels

Extruded aluminium sections for classic perimeter solutions with ceilings.

## Key Features

- // Angle and channel sections designed for compatibility with Axiom universal accessories for secure and easy installation
- // Compatible with ceiling grid systems including Silhouette and Interlude HRC designer grids
- // All ceilings – perimeters

## Physical Data

- // Material: aluminium
- // Surface finish: polyester powder paint
- // Colour: Global White / RAL 9010

## Product Range

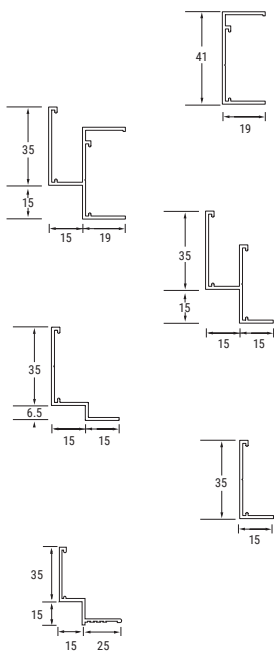

Item No.	Description	Dimensions (mm)		Standard Colours	
		Length	Height	Global White	White RAL 9010
T 3249	Axiom Perimeter C profile 41 x 19mm	3000	41	•	•
T 3226	Axiom Perimeter Shadowline channel 35 x 15 x 15 x 19mm	3000	50	•	•
T 3227	Axiom Perimeter Shadowline channel 35 x 15 x 15 x 15mm	3000	50	•	•
T 3248	Axiom Perimeter Shadowline channel 35 x 15 x 6.5 x 15mm	3000	40	•	•
T 3235	Axiom Perimeter angle 35 x 15mm	3000	35	•	•
T 3225 G	Axiom Perimeter angle 35 x 15mm	3000	50	•	•
T 3274	Axiom Perimeter for hook on metal tiles	3000	50	•	•
T 3275	Axiom Perimeter Shadowline for B-H 300 (full tiles)	3000	50	•	•

## Accessories

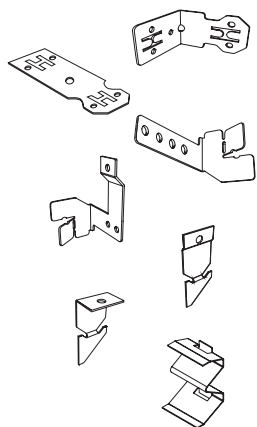

Item No.	Description	Dimensions (mm)
		Height
A 340 H	Axiom Universal corner clip	-
A 338 H	Axiom Universal spice plate	-
A 339 J	Axiom Universal T bar connector clip	-
A 344 H	Axiom Universal hanging clip	-
A 321 H	Axiom Transitions suspension clip – straight	79
A 322 H	Axiom Transitions suspension clip – angled	62
A 7935	Axiom Universal hold down clip for cut metal tiles	-

Cross Sections

Connector Clip

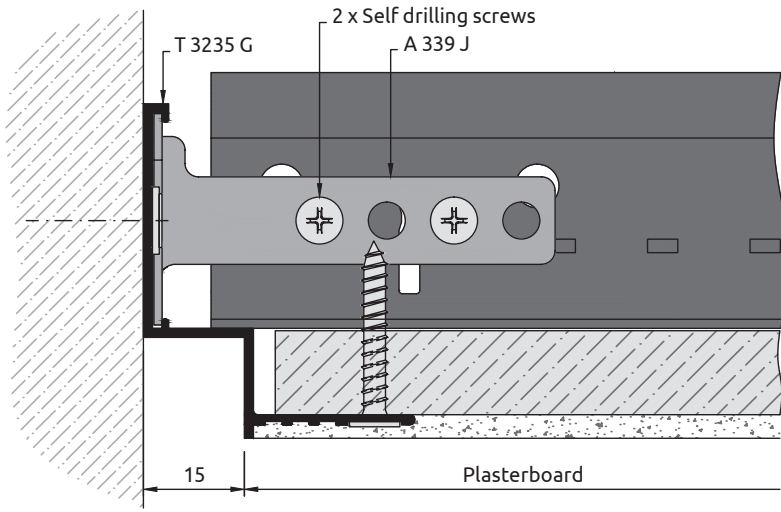

Board to Wall

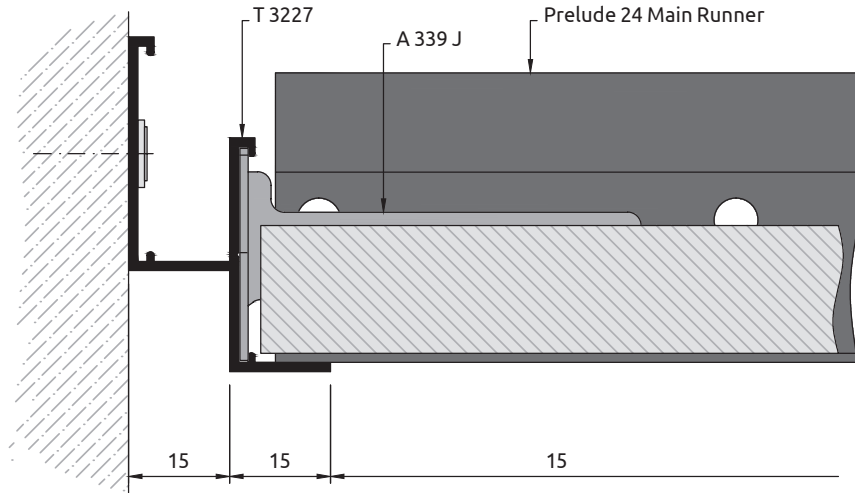

Sustainability



A+



EN 13964  
E1

Fire Reaction



EEA Euroclass A2-s1, d0  
EN 13501-1

Performances & Features



Custom Options



Dimensions



# Installation & Maintenance



For more information, please contact us or visit the Installation & Maintenance page [zentia.com](http://zentia.com)

## Manufacturer's Recommendations

Many specifications call for the ceiling to be installed in accordance with the "manufacturer's recommendations" and this approach is now adopted in BS EN 13964: 2014 "Suspended ceilings – Requirements and test methods" which refers to "Supplier's instructions".

The recommendations are given as a guide to such requirements which should be consulted prior to installation.

Where a specific point is not mentioned or for further information on those that are, please contact us or visit [zentia.com](http://zentia.com)

## Reaction to Fire

Fire reaction is an important consideration for every ceiling system – no matter how simple or complex. Our ceiling tiles are engineered to meet the most stringent industry standards. Select from a broad range of looks and acoustic options to meet your design and fire reaction requirements.

classification. Most Zentia products achieve an A2-s1,d0 performance level, which is significantly better than the most onerous internal linings classification required in the Building Regulations of class B-s3,d2.

For more information, please contact us or visit [zentia.com](http://zentia.com)

### Building Regulations

Fire reaction performance for suspended ceilings is shown using the Euroclass fire reaction



# Cleaning Matrix

		Dry Methods				Wet Methods (tiles must be cleaned using dry methods before wet cleaning)									
		A1: Soft brush A2: Clean, dry, soft white cloth A3: Vacuum system (with brush)	A4: Focus compressed air	H: Pencil erasers to remove fingerprints or pencil marks	B1: Moist cloth with no detergent C1: A moist cloth with mild detergent diluted in warm water	B2: Damp sponge with no detergent C2: Damp sponge with mild detergent diluted in warm water	D: Damp rough texture sponge; (using medium pressure)	F: High pressure water cleaning			G: Resistant to popular disinfectants (due to large number of types of disinfectants, always test a small area first)				
Mineral Solutions	ULTIMA+, ULTIMA+ dB, ULTIMA+ OP	✓	Daily	✓	✓	Weekly	✓	Weekly							
	OPTIMA	A1 & A3 Only	Daily	✓			B2 Only	Weekly							
	PERLA, PERLA dB, PERLA OP 0.95, PERLA OP 1.00, PERLA OP dB	✓	Daily		✓	Monthly	✓	Weekly							
	NEEVA COLORTONE NEEVA	✓	Daily	✓											
	SIERRA / SIERRA OP	✓	Daily	✓	✓	Monthly	✓	Weekly							
	DUNE eVo, DUNE eVo dB, DUNE eVo MAX, COLORTONE Dune eVo	✓	Daily					✓	Weekly						
	PLAIN	✓	Daily	✓											
	FINE FISSURED	✓	Daily	✓											
Specific Solutions	BIOGUARD ACOUSTIC	✓	Daily	✓	✓	Daily	✓	Daily	✓	Weekly			✓	Daily	
	BIOGUARD PLAIN	✓	Daily	✓	✓	Monthly	✓	Weekly					✓	Weekly	
	CLEANROOM FL	✓	Daily	✓	✓	Weekly	✓	Weekly					✓	Weekly	
	HYGIENE	✓	Daily	✓	✓	Weekly	✓	Weekly			✓ <sup>(1)</sup>	Twice Yearly			
	HYDROBOARD	✓	Daily	✓											
	CERAMAGUARD	✓	Daily	✓	✓	Weekly	✓	Daily							
	AQUABLOC	✓	Daily	✓	✓	Weekly	✓	Daily							

<sup>(1)</sup> Special instructions are available - Please consult us.



Wipeable with a dry cloth / soft brush (A1 - A2 - A3)



Can be cleaned using focus compressed air (A4)



Wipeable with a moist cloth (B1 - C1)



Washable with a sponge dampened in water containing mild soap or diluted detergent (B2 - C2)



Scrubable with water containing mild soap or diluted detergent (D)



Can be cleaned using a high pressure water spray (F)



Can be cleaned with disinfectants commonly used in healthcare premises (G)



# Acoustical Technical Glossary

## Weighted sound absorption coefficient, $\alpha_w$

A single-number rating for random incidence sound absorption coefficients calculated by reference to EN ISO 11654. With this method measured values obtained in accordance with EN ISO 354, are converted into octave bands at 250, 500, 1000, 2000 and 4000Hz and are plotted onto a graph. A standard reference curve is then shifted towards the measured values in steps of 0.05 until a "best fit" is obtained. The derived value of  $\alpha_w$  will vary between 0.00 and 1.00 but is only expressed in multiples of 0.05, eg  $\alpha_w = 0.65$ .

## Shape indicator

With reference to EN ISO 11654, the calculated value of  $w$  may be qualified by one or more letters (in brackets) to indicate if the product has excess sound absorption at low (L), medium (M) or high (H) frequencies.

## Sound absorption class

With reference to EN ISO 11654, the calculated value of  $w$  may additionally be allocated into one of six descriptive classes in accordance with the following table:

Sound absorption class	$\alpha_w$
A	0.90; 0.95; 1.00
B	0.80; 0.85
C	0.60; 0.65; 0.70; 0.75
D	0.30; 0.35; 0.40; 0.45; 0.50; 0.55
E	0.15; 0.20; 0.25
Not classified	0.00; 0.05; 0.10

## Weighted suspended ceiling normalised difference, $D_{ncw}$

A single-number rating of the laboratory measurement of room-to-room (horizontal) airborne sound insulation of a suspended ceiling above adjacent rooms sharing a common ceiling plenum. It is determined in accordance with EN ISO 717-1 from measurements made in accordance with EN 20140-9. Note: EN 20149-9 has now been withdrawn and superseded by EN ISO 10848-2. (see  $D_{nfw}$ ), although  $D_{nfw}$  test results still continue to be valid.

## Weighted suspended ceiling normalised flanking difference, $D_{ncw}$

A single-number rating of the laboratory measurement of room-to-room (horizontal) airborne flanking sound transmission of a suspended ceiling above adjacent rooms sharing a common ceiling plenum. It is determined in accordance with EN ISO 717-1 from measurements made in accordance with EN ISO 10848-2. This has now superseded EN 20149-9. (see  $D_{nfw}$ ).

## Advisory Note

All photographic and design elements supplied in this brochure do not necessarily reflect any recommendation by any of the companies named in this brochure as to the proper use or recommended methods of installation of suspended ceilings and are supplied only as informative material. For technical reasons in printing, differences may appear between colours printed in this brochure and the actual product. The choice of colours should always be made from a sample of the product. All statements and technical information contained in this brochure, or any publication of the companies named in this brochure, relating to Zentia are based on results obtained under laboratory test conditions. It is the responsibility of the user to verify with the seller of the products in writing that such statements and information are appropriate to the specific use intended. Sales of the products and liability of the selling companies are in accordance with the terms and conditions of sale of the selling company. All product specifications are subject to modifications without prior notice.

2020© Jiri Parizek, Szymon Polański, Studio Vu, Grigori Rassinier, Bernard Gallandi, Philip Durrant, Nike Bourgeois, Simon Miles, Žiga Intihar, Mitch Van Leeuwen, Joao Morgado, Francisco Urrutia, Miguel de Guzman, Staehli Architects, Beat Bühler, U. Beutemülle, Graham Tooby, LBDI Communication, Nail Viyatdinov, Rafael Vargas, Simon Garcia, Luis Sans, Beppe Raso, Blax Digital, Jim Stephenson, Gerard Van Beek, Miran Kambic, Blackriver Production, Romain Boileux, Marc Sourbron, Michael Van Oosten, David Gunttsch, Ivan Lambrev, Sonja Bell Fotografijn, Daan Verhost, Infinite 3D Limited, Dan Verhorst, Claude Fiscaro, Dave Parker, Paul Zanre.

## Weighted sounds reduction index, $R_w$

A single-number rating of the laboratory measurement of (vertical) airborne sound reduction of a suspended ceiling. It is determined by reference to EN ISO 717-1 from measurements of sound reduction index made in accordance with EN ISO 140-3.

## Rain noise sound intensity level, $L_r$

The laboratory measurement of the sound intensity in a room below a roof construction when subjected to rainfall. It is determined by reference to EN ISO 140-18:2006 – Laboratory measurement of sound generated by rainfall on building elements. The roof's performance can be tested with or without a suspended ceiling beneath. The intensity of the rainfall tested can be selected from the options given in the standard. A combined A-weighted single-number (LIA) can also be determined. Unlike  $D_{nfw}$  and  $R_w$  data, where the =higher the value the better the insulation provided, the lower the intensity value (weighted LIA) the better the insulation performance of the ceiling and roof combination.

## Sound attenuation

A term used in relation to the horizontal transmission of sound through a suspended ceiling above adjacent rooms sharing a common ceiling plenum.

## Sound reduction

A term used in relation to the vertical transmission of sound through a suspended ceiling.

## Noise reduction coefficient, NRC

A single-number descriptor of random incidence sound absorption coefficients. Defined in ASTM C423 as the arithmetical average, to the nearest multiple of 0.05, of the measured sound absorption coefficients for the four one-third octave band centre frequencies of 250, 500, 1,000 and 2,000 Hz.

## Sabine / equivalent absorption area (EAA)

A Sabine is a measure of the total sound absorption provided by discrete objects (canopies, screens, furniture, etc) when installed in an architectural space. Because these types of absorbers have more than one surface and may be irregular in form, it is not meaningful to assign sound absorption coefficients to them. Hence the Equivalent Absorption Area per unit (measured in Sabines) is preferred to characterise the absorption provided by an individual 'space absorber'.

# Discover our new website



## 1. Ceiling Tiles

Browse by product type to find the best ceiling solution.

## 2. Suspension Systems

Find a suspension system by category or installation type and get a full system solution.

## 3. Floating Ceilings

Browse for the different shapes and solutions of ceiling canopies.

## 4. Applications

Browse by segment or special application to accurately match your ceiling space requirements.

## 5. Performance

Search by performance or sustainability criteria, with best solutions visible at a glance.

## 6. Product Gallery

Check out latest project images, videos and case studies to help create your next project.

## 7. Technical Downloads

Find technical documentation and resources including data sheets, installation and warranty files, CAD drawings and BIM objects.

MLB 059.1.07.22