

INSTALLATION GUIDE

Rockfon® System T24 X™

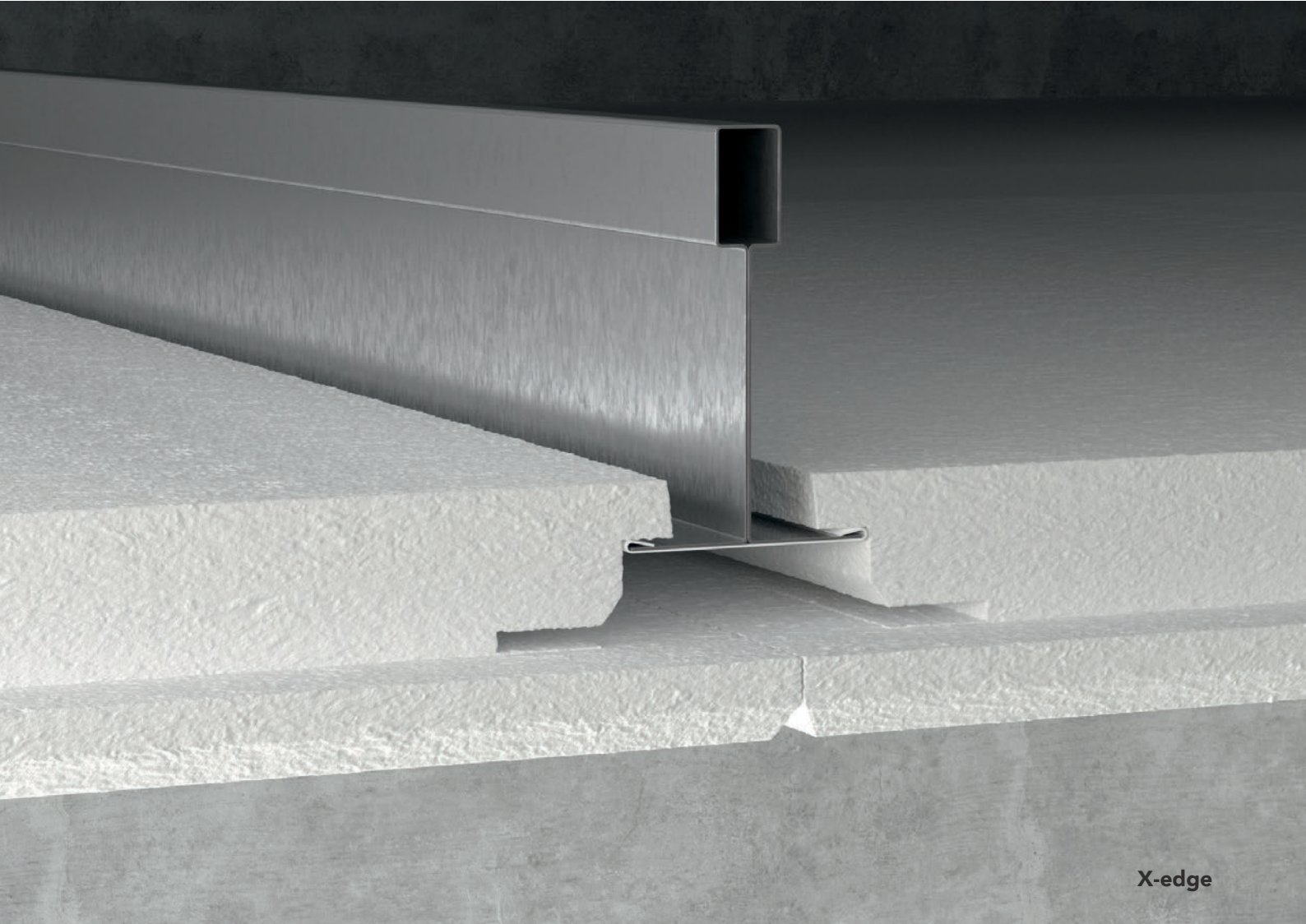

X-edge

Concealed ceiling system
Continuous expression

- Elegant, continuous ceiling expression
- Quick and easy to install
- Low installation height and full demountability
- Easy integration of services

Sounds Beautiful

Description

Rockfon System T24 X is a concealed ceiling system that provides an elegant, continuous ceiling expression and is used with X edge tiles. The system can either be installed as a suspended ceiling at the desired height using the **Chicago Metallic T24 Click 2890 grid** or installed directly to the soffit by using direct fixing brackets.

In Rockfon System T24 X the **Chicago Metallic T24 Click 2890 grid** has a click connection provides quick and easy installation and demounting. The T profiles have a width of 24 mm, and all components are made of galvanised steel with a smooth, white surface concealed by Rockfon X edge tiles.

The system includes main runners, cross tees, hangers and other necessary components.

The main runners and cross tees have a uniform height of 38 mm, ensuring stability and easier integration of services.

A number of accessories, lighting and ventilation solutions have been developed for Rockfon System T24 X.

The system enables full demountability of the installed tiles. The system is characterised by symmetrical, fully independent tiles. Rockfon X edge tiles are available in different module sizes (see overview on page 3). The grid layout to be used depends on the choice of the module size (see layout possibilities on page 5).

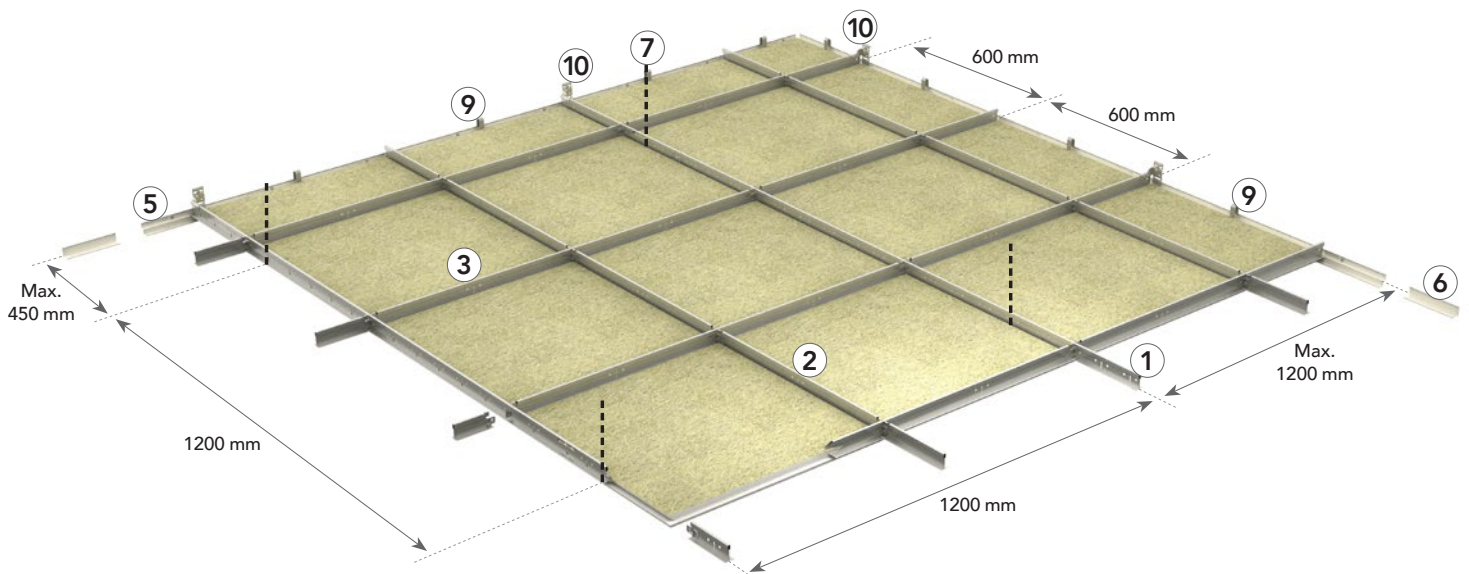

To make sure that the tiles of a Rockfon System T24 X are perfectly positioned, we recommend the use of the wall spring fixt.



To ensure the squareness of the Rockfon System T24 X it is recommended to use a wall bracket on every main runner and every second cross tee.

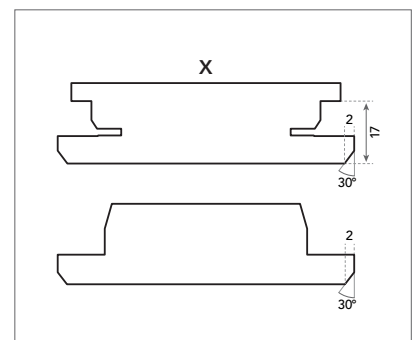

Concealed grid system with the symmetrical X edge tile ensuring quick installations in both directions.

System components and consumption guide

Tile	Chicago Metallic T24 Click 2890				Wall angles		Accessories				
	1	2	3	4	5	6	7	8	9	10	
-	Main runner T24 Click 3600 mm	Cross tee T24 Click 600	Cross tee T24 Click 1200	Cross tee T24 Click 1800	W Shadow moulding wall angle	Perimeter wall angle trim	Rigid angle hanger	Direct suspension clip	Wall spring FIXT	Wall & bridging bracket	
Dimension (mm)	Consumption/m ²										
600 x 600	2.78 pcs/m ²	0.83 lm/m ²	0.83 lm/m ²	1.67 lm/m ²	-	1)	1)	0.70 pcs/m ²	0.70 pcs/m ²	2)	1)
1200 x 600	1.39 pcs/m ²	0.83 lm/m ²	-	1.67 lm/m ²	-	1)	1)	0.70 pcs/m ²	0.70 pcs/m ²	2)	1)
1800 x 600	0.93 pcs/m ²	0.55 lm/m ²	-	-	1.67 lm/m ²	1)	1)	0.70 pcs/m ²	0.70 pcs/m ²	2)	1)
2100 x 600	0.79 pcs/m ²	1.76 lm/m ²	0.48 lm/m ²	-	-	1)	1)	1.38 pcs/m ²	1.38 pcs/m ²	2)	1)
2400 x 600	0.69 pcs/m ²	1.67 lm/m ²	0.42 lm/m ²	-	-	1)	1)	1.38 pcs/m ²	1.38 pcs/m ²	2)	1)

1) Consumption depends on room size.

2) Wall spring fixt is used to block the tile. When wall spring fixt is used, make sure there is enough space between the tile and the wall to insert the spring. Use one spring per tile.

Tile - X Edge

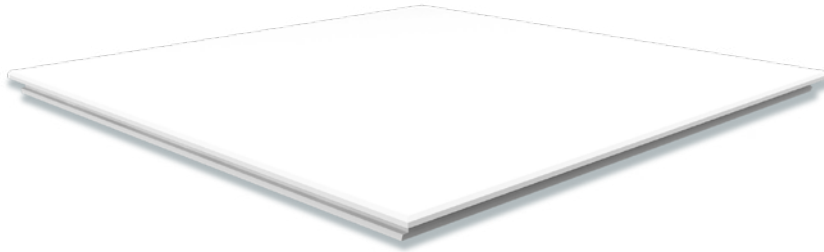

Chicago Metallic T24 Click 2890

1. Main runner T24 Click 3600 mm



2. Cross tee T24 Click 600 mm



3. Cross tee T24 Click 1200 mm



4. Cross tee T24 Click 1800 mm



Wall angles

5. W Shadow moulding wall angle



6. Perimeter wall angle trim



Accessories

7. Rigid angle hanger



8. Direct suspension clip



9. Wall spring FIXT



10. Wall & bridging bracket



Performance



System load bearing capacity

		Max. Load (kg/m ²)	
Hanger distance (mm)	Dimensions (mm)	Max. 2.5 mm deflection	Max. 4.0 mm deflection
1200	600 x 600	9.9	16.5
1200	1200 x 600	10.9	17.9
1200	1800 x 600	-	5.7
1200	2100 x 600	32.9	34.7
1200	2400 x 600	31.3	34.5

For 1800 x 600 mm tiles the use of stabilising profiles is recommended in case extra load is applied on the system. Contact Rockfon for more info. The system's load capacity is determined from a max. deflection of the individual components corresponding to 1/500 of the span or the cumulative deflection of all structural components which does not exceed 2.5 or 4 mm. The load bearing capacity is given as regularly distributed load in kg / m², the weight of the tile is not included.

For the 2100 x 600 and 2400 x 600 tiles main runners are positioned at 600 mm centres.



Corrosion resistance

Class B (EN13964)



Demountability

Tiles mounted in Rockfon System T24 X are fully demountable.



Fire resistance

Some Rockfon ceiling systems have been tested and classified in accordance with European norm EN 13501-2 and/or national norms. Please contact Rockfon.

Compatible Tiles Overview

Rockfon System T24 X is available with the following Rockfon tiles:

		Dimensions (mm)				
Tiles	Thickness (mm)	600 x 600	1200 x 600	1800 x 600	2100 x 600	2400 x 600
Rockfon® Blanka™	22	•	•	•		
Rockfon® Blanka™	25				•	•
Rockfon MediCare ^{Plus}	22	•	•			
Rockfon Color-all	22	•				
Rockfon Color-all Special	22	•				

Other dimensions can be installed in Rockfon System T24 X. Please contact Rockfon.

Grid Installation

Grid layout and hanger location

Rockfon X edge tiles can be installed in Rockfon System T24 X.

Some layout options are shown below depending on the size of the tile.

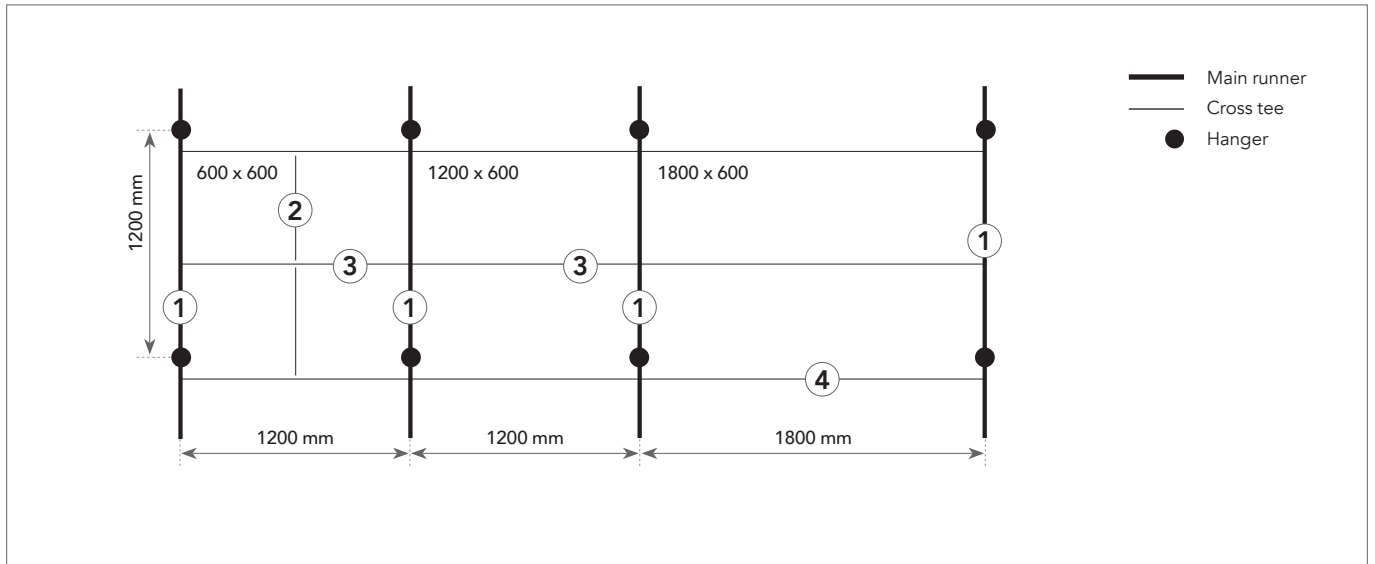

Installation requirements

During and after grid installation, it is important to check that T profiles are perfectly aligned horizontally. A maximum level difference of +/- 1 mm is recommended between profiles and should not be added. This tolerance is valid for all directions.

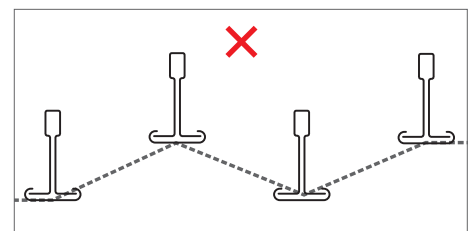
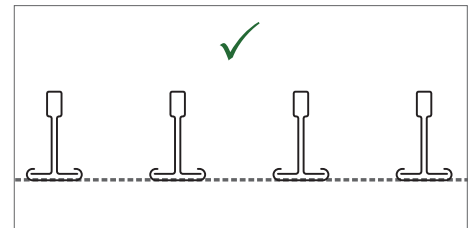

It is also important to check the squareness of the angles between the main runners and cross tees. This can be easily done by comparing the measurements of the two diagonals. See recommended tolerances on the drawings to the right.

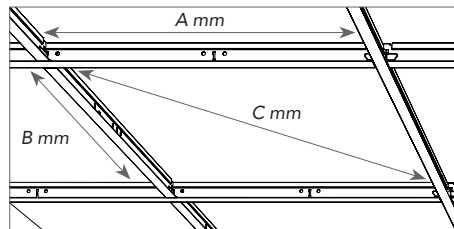

Module size (A x B)	Diagonal (C)	Tolerance
mm		
600 x 600	814.6	+/- 0.5
1200 x 600	1309.5	
1800 x 600	1867.1	
2100 x 600	2154.4	
2400 x 600	2444.8	

Tile Installation

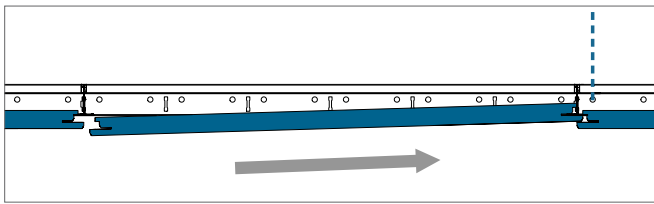

Slide the X1 edge of the tile into the T profile.

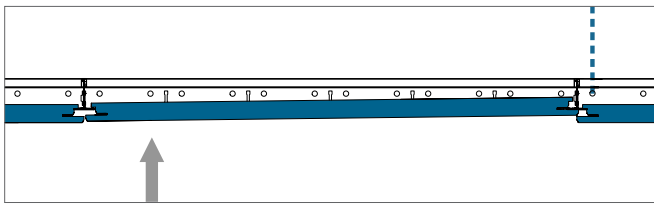

Lift the upper side of the opposite X1 edge of the tile above the T profile.

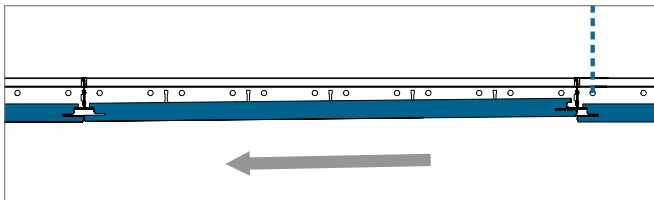

Pull the tile back.

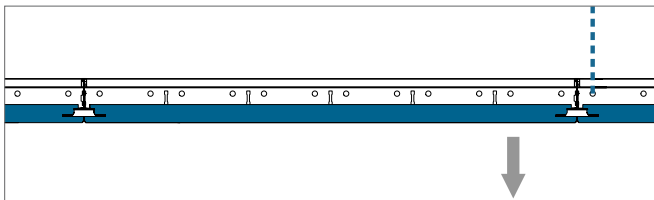

Drop the tile carefully into position.

Minimum installation depth (mm)

Tiles installed in Rockfon System T24 X are demountable. The system is characterised by symmetrical, fully independent tiles.

The installation depth is defined as the distance from the underside of the tile to the underside of the substrate, where the hangers are fixed. D is the minimum installation depth for easy tile installation and demountability.

Mounting method	D = Minimum installation depth
Direct fixing	96 mm; 116 mm
T profiles with hangers	126 mm

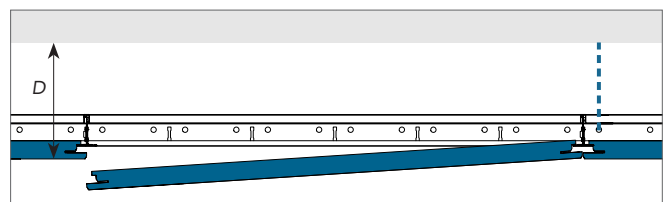

Perimeter Finish Options

Below are examples of perimeter finishing. Further details can be found on www.rockfon.co.uk

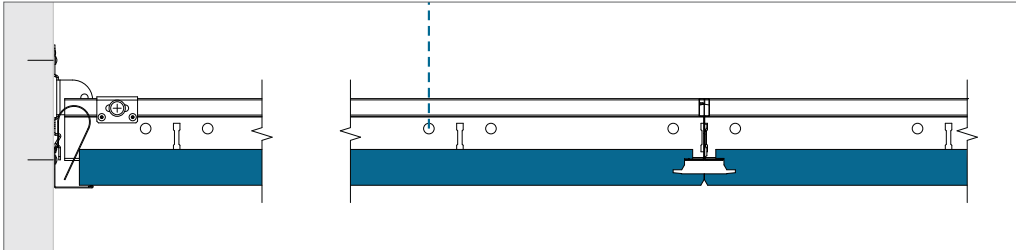

Perimeter finish with wall angle trim.

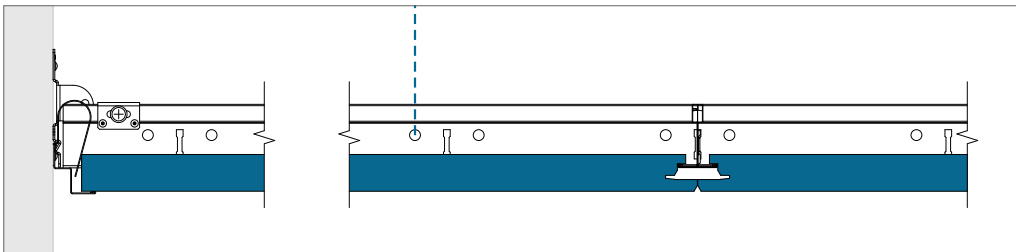

Perimeter finish with W shadow moulding wall angle.

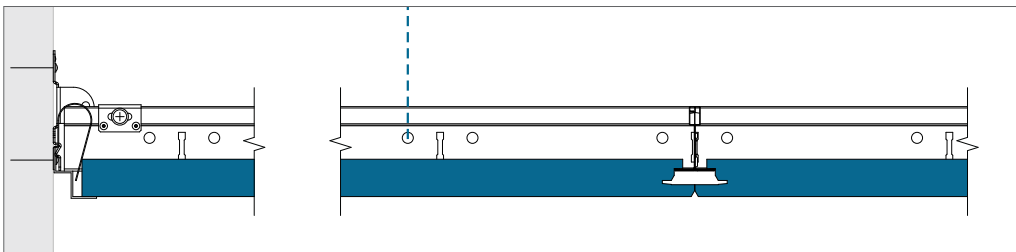

Perimeter finish with aluminium W shadow moulding wall angle.

Service integration

Rockfon ceiling tiles are easy to cut and therefore it is very easy to integrate services in our ceiling tiles. The cut-outs can be made with a simple utility knife.

When the system is load bearing, Rockfon recommends using a yoke or extra support arms that spread the weight of the service installation. Please be aware that, when installing a yoke or support arms, the tile is supported by the grid on only two sides. The size of the yoke should not be bigger than module 600 x 600 mm and the use of extra hangers to overcome deflection in the ceiling system is strongly recommended. When using support arms to spread the weight of the installation, Rockfon recommends spanning maximum 600 mm.

Planning

A thorough project plan will result in less re-work and less ceiling tile damage. We recommend discussing the installation thoroughly and well in advance with other installers that have to work in or near the suspended ceiling. By doing so damaged ceiling tiles and dirty spots on the finished ceiling surface can be reduced, which reduces costs on site.

When installing a modular lighting fixture in Rockfon System T24 X please be aware of the special edge design and module size of this solution. Because of the ceiling tile design, a special type of luminaire should be chosen in order to create an aesthetically pleasing and well leveled ceiling surface. The actual size of the ceiling tile is nearly its module size and the front surface of the ceiling tile sits approx. 16 mm below the front of the T-grid.

Overview load bearing capacity

	Weight of installations		
	< 0.25 kg/pcs	0.25 ≥ 3.0 kg/pcs	> 3.0 kg/pcs
Small service integration; Spot- or downlight, speaker, ventilation etc.	Drawing A	Drawing B	Suspend separately
Large service integration; Downlight, speaker, ventilation, etc.	Drawing A	Drawing B	Suspend separately
Modular lighting- or ventilation fixture	Drawing C; System load bearing capacity (if evenly distributed over grid in kg/m ²)		

When installing services in Rockfon System T24 X you should always follow local building regulations if more strict than the load bearing capacity guidelines Rockfon recommends in the above table and in the table on page 4.

Contact your local Rockfon technical service for more information on suitable lighting fixtures and accessories and availability of CAD drawings of the different services integrated in Rockfon System T24 X. Special solutions with integrated services are, if available, shown on page 12 of this document; in the Tools section.

Drawing A

The integration of a spotlight, smoke detector, speaker, etc. (weighing < 0.25kg/pcs).

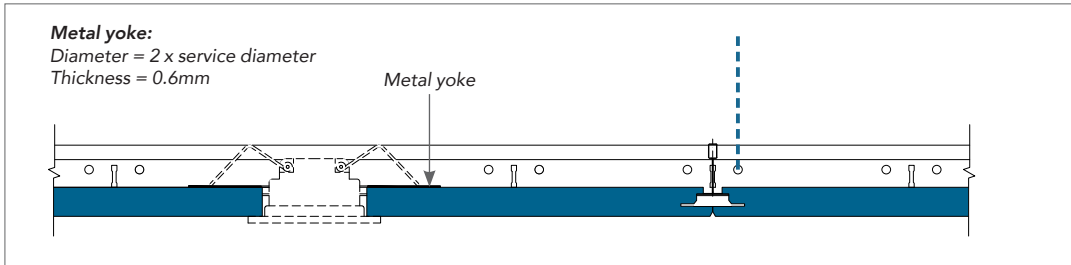

Drawing B

The integration of a downlight, spotlight, smoke detector, loud speaker, etc. (weighing $0.25 \geq 3.0\text{kg/pcs}$).
 Use of a plywood yoke to spread the load on the back of the tile (as shown in the detail) or use of support arms to spread the load to the grid system is strongly recommended. The use of additional hangers to reduce deflection is strongly recommended.

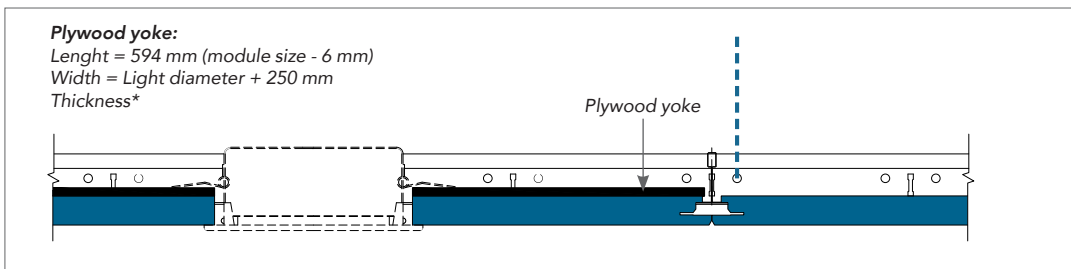

* The thickness of the plywood or metal yoke needs to be adapted in function of the weight, size and position of your service integration (e.g. downlight or speaker). The Plywood or metal yoke itself may not deflect after installing your service integration.

Drawing C

The integration of a modular lighting fixture or air vent (evenly distributed over grid), weighing max. the system loading capacity. It is strongly recommended to suspend the service independently.

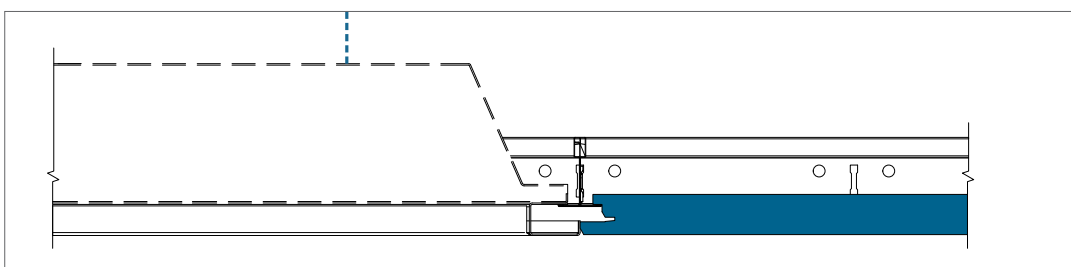

Specific Solutions

Hold down clip

For maintaining tiles in place, Rockfon offers a range of hold-down clips. In smaller rooms, hallways, stairwells, etc. which can be exposed to air pressure differences between the ceiling void and room, it is recommended that ceiling tiles are clipped at the back.

This is also recommended for cleaning purposes. For further info on our hold down clips please refer to our Hold Down Clips brochure.

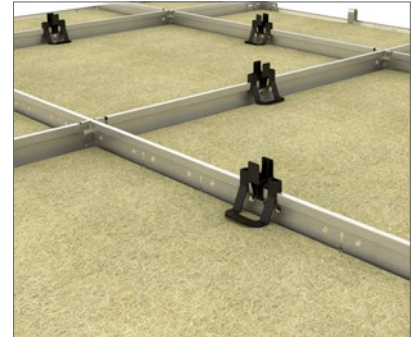

Light frame

Made exclusively for our Rockfon System T24 X, the easy to mount light frame for our X-edge concealed ceiling tile securely fits into the grid, providing an aesthetic and practical finish. It allows for the easy installation of both a light frame and other important service integration without compromising the visual finish of the total ceiling, leaving no gaps between the light frame and the X-edge tile.



X-edge knife

Installing perimeter tiles can be a challenge, due to cross tees and perimeter trim sitting too close to each other. This specially developed X-edge knife gives you an extra 25 mm installation space. By removing a piece from the back of the tile, you will be able to slide the tile over your cross tees, install it and slide it back on to your perimeter trim. Watch our Rockfon System T24 X installation video for further information.

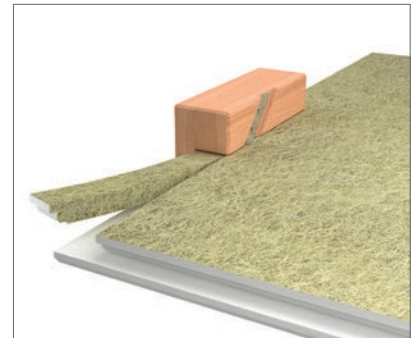

Bridging (Eliminate deflection)

Perfectly optimised for our Rockfon suspension grids, the bridging bracket enables you to secure your T profiles across a variety of tile thicknesses ranging from 0 mm (only relevant for our Chicago Metallic™ T24 Click 2890 or Chicago Metallic T24 Click 2790) to 20 mm.

Easy to install, the bracket is a versatile, non-combustible component that can be used for service integration with different dimensions without the need for a using a yoke or patress.

To install the Bridging function of the bracket, simply screw fasten the Wall & Bridging Bracket for T profiles to your main runners and cross tees, transferring the weight of the service to the grid. This ensures that no load rests on the tile, eliminating concerns of deflection.

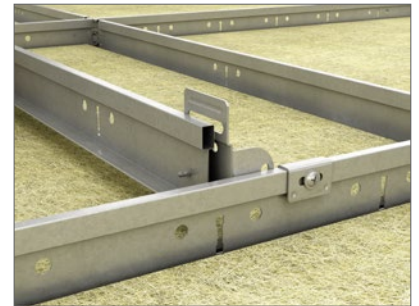
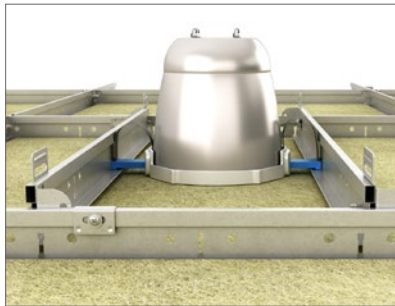

General installation recommendations

Junction between ceiling and wall or other vertical surface

The perimeter trim should be fastened to vertical surfaces at the required level using appropriate fixings replace at 300-450 mm centres. Ensure that butt joints between adjoining lengths of trim are neat and that the trim is free from kinks and remains true and level. For the best aesthetics, use as long a length of trim as possible. The minimum recommended cut length is 300 mm.

Timber trims, timber shadow battens and metal

Shadow mouldings should not be used with fire resisting/protecting ceilings.

Junction between ceiling and curved vertical surface

The use of a preformed curved perimeter trim is the most appropriate method. Rockfon can provide details of curved perimeter trims on request.

Corners

Perimeter trims should be neatly mitred at all corner joints. Overlap mitres are acceptable on metal trims on internal corner joints unless specified otherwise.

Suspension grid

Unless specified otherwise, the ceiling should be set out symmetrically and where possible, perimeter tiles should be greater than 200 mm in width. The hangers should be fastened with appropriate top fixings and to the main runners at 1200 mm centres (or less with greater load).

Main runners should be positioned at 1200 mm centres for 600 x 600 mm and 1200 x 600 mm module sizes. For 1800 x 600 mm module size, main runners are installed at 1800 mm centres.

For proper grid installation, ensure the T profiles are perfectly aligned, horizontally and diagonals of modules are equal (see requirements and tolerances on page 5). Main runner joints should be staggered and there should be a hanger positioned within 150 mm of the fire expansion element/cut-out and within 450 mm of the end of the main runner where it terminates at a perimeter.

Additional hangers may be necessary to support the weight of ceiling services. When using direct hangers, a fixing pin should be used to lock the hanger on to the bulb of the main runner.

Tiles

We recommend the use of clean nitrile or PU coated gloves when installing Rockfon tiles in order to avoid fingerprint marking on the surface.

Cutting is made easy with a sharp knife.

For an optimum work environment, we recommend installers always observe common work practices and follow the installation advice as shown on our packaging.

Installation of 1800 x 600 mm and larger planks is recommended to be carried out by two people.

Note! Certain smooth matt surfaces are directional. To ensure consistency of the finished ceiling, it is important that all tiles are installed in one direction indicated by the arrow printed on the back of each tile.

Tools

Rockfon has developed specific tools that are available on www.rockfon.co.uk.

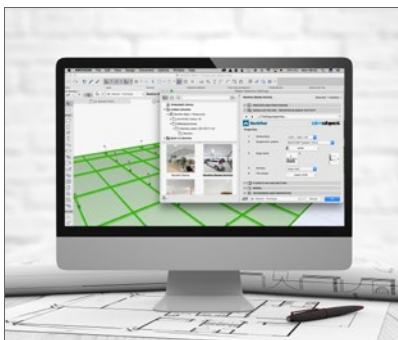

For further information visit the CAD library.

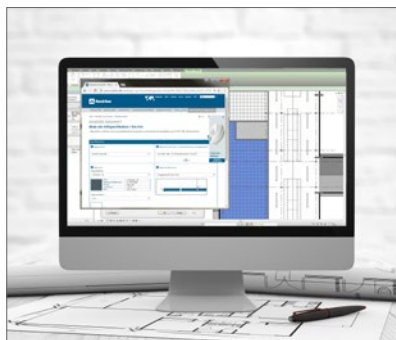

Generate specification texts for our products.



Explore our vast library of reference project.

Sounds Beautiful

